











Borroughs
CORPORATION

INDUSTRIAL STORAGE
PRODUCTS CATALOG

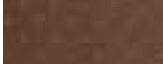

THE BORROUGHS CORPORATION	4-6
 BOX EDGE PLUS®	7
HIGH DENSITY DRAWERS	31
 RIVET-SPAN® BOLTLESS SHELVES	45
 MODULAR DRAWER CABINETS	61
 FLEXI-BINS®	91
 SHOP EQUIPMENT	95
 B-SPAN® WIDE-SPAN SHELVING	117
 AISLE-SAVER® MOBILE SYSTEM	125
 SLOTTED ANGLE	129
 HIGH-RISE & MULTI-TIER SYSTEMS	131

THE BORROUGHS CORPORATION

OUR PRODUCTS, OUR PROCESSES AND YOUR SUCCESS

Thank you for your interest in our company, the products and services we produce and represent. For close to a century we have been delivering the highest quality Storage and Material Handling Equipment for companies and enterprises of all sizes – which continues to be a source of great pride in our company’s history and culture. Whether you are storing cans of motor oil, plumbing supplies, or building a distribution or fulfillment center, Borroughs has a solution to help.

The history of our company, that began with Walter Borroughs, has been one of success measured simply by being invited back by our customers. More than any other aspect of our company we pride ourselves in our people. No matter what their job or title may be, our employees represent, what we believe to be, the best manufacturer of storage equipment and services for your needs.

Over the years we have grown by listening to the needs of our customers both current and future. The needs to move your enterprise forward - be it with capital projects or simply strong, secure storage - coupled with Borroughs' high quality products, technical support, engineering and people dedicated to getting the job done right, is our mission for success.

– Tim Tyler, President & CEO



cir. 1950



HOW WE DO WHAT WE DO

INVESTED IN DESIGN

As a national leader in the designing and manufacturing of quality storage systems, we continually help customers achieve their goals in terms of efficiency, productivity, security and cost. To assist in our efforts Borroughs utilizes Configura rendering software. Configura allows us to interface with architectural drawings, makes planning simpler, and produces 3D renderings of your facilities and storage systems during the planning phase. All of this prior to manufacturing and installation.

This forward thinking approach protects you from costly mistakes and gives full insight into how your storage systems will appear prior to purchase. Couple that with our project management capabilities and customer service and you have a process set in place to create the highest customer satisfaction possible.

INVESTED IN QUALITY

Practicing consistency in quality processes is primary to Borroughs' philosophy and operations of delivering the best products and components possible. Borroughs Corporation maintains ISO 9001:2000 certification for quality procedures and product design, and ISO 14001:2004 for environmental practices and ongoing efforts to reduce our waste streams and the use of natural resources.

On top of this, Borroughs constantly upgrades its manufacturing capabilities, machinery and equipment. These quality procedures and upgrades allow us to track your order from raw coils of steel, to each process of manufacturing, through shipping.

The quality of Borroughs products encompasses many aspects like fit, finish, and function. Our quality always includes customer service and support before, during and after the sale. Making sure that Borroughs products arrive to you the way they are advertised and meet your expectations.



Ordering from the Borroughs Corporation

To order Borroughs storage and equipment products, please contact your local authorized Borroughs Representative or a Borroughs Regional Manager.

A complete list of Regional Managers and their territories is available at **www.borroughs.com**

All other inquiries please contact our

Customer Service Department at 1-800-748-0227.

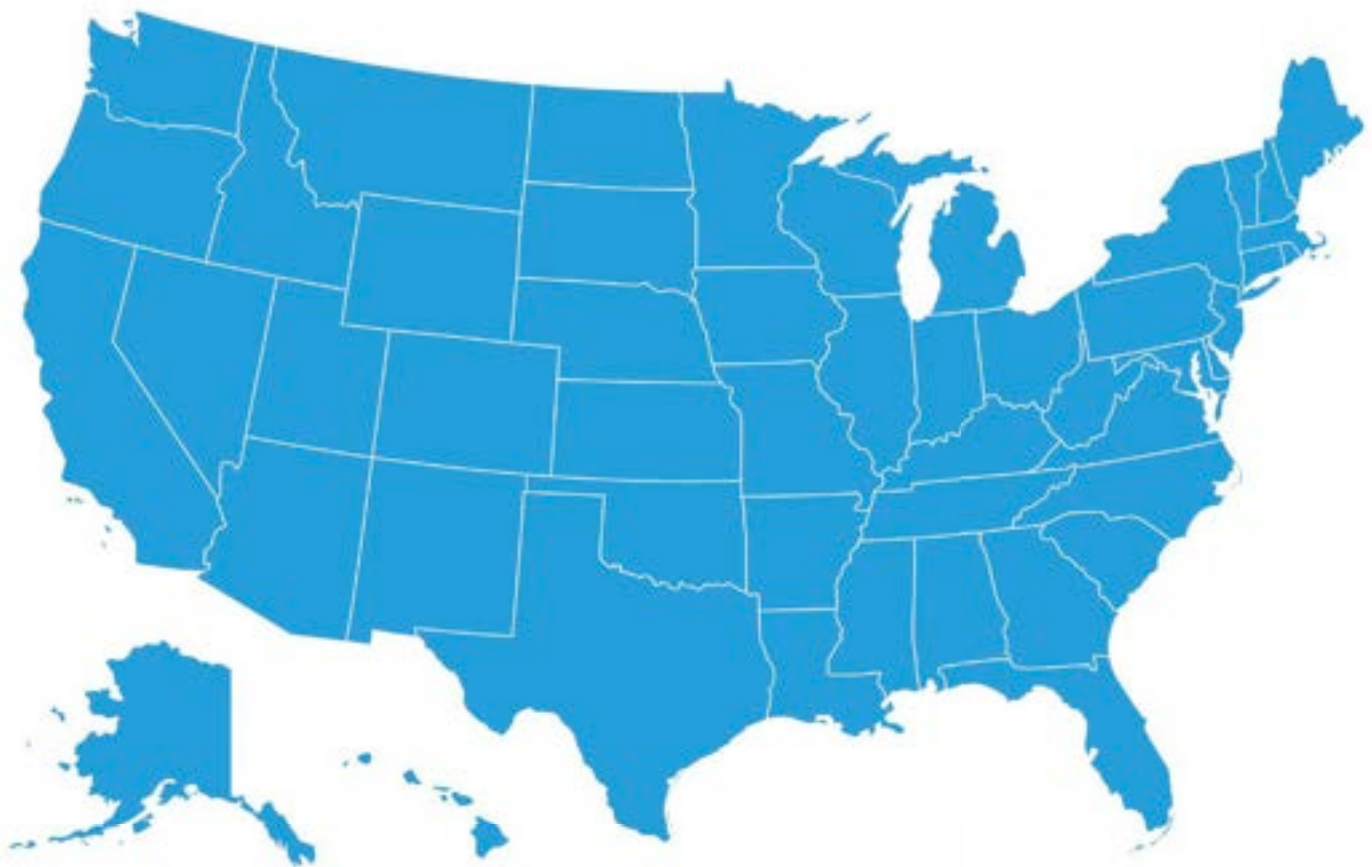

Scan this QR Code to go to a listing
of **Regional Managers** and their
territories on www.borroughs.com.



BOX EDGE PLUS® STORAGE SYSTEM CLIP-TYPE SHELVING

One Storage System, Endless Configurations.

The wide offerings of Box Edge Plus Storage systems deliver a complete system for all your inventory demands. This system can be as simple as a one-story unit with heavy-duty shelves for replacement parts, or as complex as a highly engineered multi-level e-commerce facility—

all designed to maximize your cubic volume capacity. Numerous posts, beams, shelves and accessories allow for easy customization. The storage options are many: high-density drawers protect small parts and expensive items, shelf dividers keep inventory organized, and doors

secure select merchandise. Counters can be configured, conveyors easily integrate, and overall increased efficiency is the end result. Borroughs Box-Edge Plus Storage System—it's the storage system that can do it all.

- Open unit type
- Closed unit type
- Open and closed backs
- Perforated end panels
- Shelf dividers - fixed and adjustable
- Bins and bin fronts
- Cabinets
- High density drawers
- Counters
- Multi-level
- High bay

24" Deep, Box Edge Units with HD Drawers in Shelves. Installed at Estero Chevrolet - Naples, FL.



Scan this QR Code to
download **Box-Edge**
installation instructions

BOX EDGE PLUS®



DESIGN FEATURES

Our Box Edge Plus Shelf is designed for additional value and aesthetics without additional investment. The simplicity of Borroughs unique Box Edge design ensures structural rigidity, ease of shelf adjustability, as well as fast and easy assembly—saving time and money.

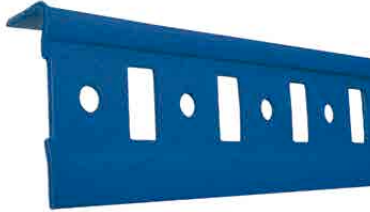

ANGLE POST

Our angle post is designed for maximum strength and stability, while at the same time providing flexibility for changing requirements. It is ideally suited for free-standing shelving units.



BEADED POST

Borroughs beaded post reduces the front flange to create additional clearance for shelf space. The resulting wider shelf opening provides for more strength, and usable shelf space, while also giving a more aesthetic appearance.



HIGH-RISE POST

This post was developed by Borroughs engineers to allow maximum strength in a post compatible with multi-level systems available from Borroughs. The result—an industry exclusive.



BOX EDGE CONSTRUCTION

The front and rear edges of the shelf are formed into a closed, welded box shape, providing additional strength to handle impact or point loads.



REINFORCED CORNERS

Sturdy lapped and welded corners reinforce shelf strength and maximize load capacity.

CLEANER FRONT EDGE

The Box Edge Plus shelf has a clean front edge with no ridges or protrusions. Stored items slide smoothly on and off the shelves.



SHELF BRACKET

Shelf brackets provide wide load-bearing surfaces for quick and easy installation—without the use of tools, nuts or bolts. Shelves can even be rearranged without disturbing adjoining units.

DESIGN FEATURES & BASIC DATA

HEIGHTS	Borroughs has seventeen standard post heights ranging from 3'3" to 19'3" for optimal use of your vertical space. Even taller units are possible using standard post splicers.
WIDTHS	Borroughs steel shelving is available in four standard widths to meet your specific storage needs. Protect your inventory investment and save valuable storage cube with the correct width shelving.
DEPTHS	Borroughs steel shelving comes in seven standard depths from 12" to 36" for efficient storage of a variety of items. Maximize your facility and stock picking efficiency with the optimum depth shelving.
ACCESSORIES	With the addition of our broad range of accessories, your shelving can be designed to meet your exact needs. Everything from motors to micro-chips can be stored safely and efficiently.
FAST ASSEMBLY	The unique design of the Borroughs shelf bracket ensures fast, easy assembly – saving time and money.
EASY ADJUSTMENT	Shelf adjustment is easy because the Borroughs shelf bracket captures shelves rather than "binding" them.
DURABLE FINISH	Borroughs Powder Coat Paint systems are state of the art, resulting in a durable, furniture quality finish – one of the best in the industry today.
ENVIRONMENTALLY CONSCIOUS	Our Green ISO 14001:2004 registered processes exceed current environmental standards and our powder coating contains no ingredients banned by the EPA. Borroughs' powder coat finished surfaces will not emit any chemical compounds or VOC's into the air during use.

CAPACITY TESTING PROCEDURES

Borroughs Box Edge Plus shelving weight capacities were derived using the standards set forth by American National Standards Institute ANSI-MH28.1-1997 and Shelving Manufacturers Association (SMA) Specification for the Design, Testing, Utilization, and Application of Industrial Grade Steel Shelving publication.

The capacities listed are for uniformly loaded shelves. They were determined using testing procedures that conform to the standards of the Shelving Manufacturers Association. Shelves were tested for both capacity and acceptable deflection.

BOX EDGE PLUS® SHELF CAPACITY				
Size W x D	Box Edge Plus 0 (24 g.)	Box Edge Plus 1 (22 g.)	Box Edge Plus 2 (20 g.)	Box Edge Plus 3 (18 g.)
24" x 12"	–	600 lbs.	–	–
36" x 12"	420 lbs.	600 lbs.	800 lbs.	1100 lbs.
42" x 12"	–	–	600 lbs.	1000 lbs.
48" x 12"	220 lbs.	400 lbs.	500 lbs.	800 lbs.
36" x 15"	–	600 lbs.	800 lbs.	1100 lbs.
42" x 15"	–	–	600 lbs.	1000 lbs.
48" x 15"	–	–	500 lbs.	800 lbs.
24" x 18"	–	600 lbs.	–	–
36" x 18"	400 lbs.	600 lbs.	800 lbs.	1200 lbs.
42" x 18"	–	–	600 lbs.	1000 lbs.
48" x 18"	210 lbs.	400 lbs.	500 lbs.	800 lbs.
24" x 24"	–	600 lbs.	–	–
36" x 24"	460 lbs.	600 lbs.	800 lbs.	1200 lbs.
42" x 24"	–	–	600 lbs.	1000 lbs.
48" x 24"	200 lbs.	400 lbs.	500 lbs.	800 lbs.
36" x 30"	–	–	600 lbs.	900 lbs.
42" x 30"	–	–	600 lbs.	1000 lbs.
48" x 30"	–	–	500 lbs.	750 lbs.
42" x 32"	–	–	650 lbs.	1000 lbs.
36" x 36"	–	–	400 lbs.	600 lbs.
42" x 36"	–	–	450 lbs.	600 lbs.
48" x 36"	–	–	450 lbs.	700 lbs.

DESIGN FEATURES & BASIC DATA

HEIGHTS

Borroughs has seventeen standard post heights ranging from 3'3" to 19'3" for optimal use of your vertical space. Even taller units are possible using our many standard post splicers.



Nominal height: One foot increments from 3'3" to 19'3". Actual height is the nominal height minus 1/4" ±1/16".

Note: Unit anchoring is recommended when the height to depth ratio exceeds 4. Example: 7'3" high x 18" deep unit has a height to depth ratio of 4.873 and should be anchored to a firm restraint such as a floor or wall.

17 STANDARD Post Heights

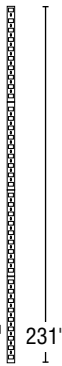

WIDTHS

Borroughs steel shelving is available in four standard widths to meet your specific storage needs. Protect your inventory investment and save valuable storage cube with the correct width shelving.

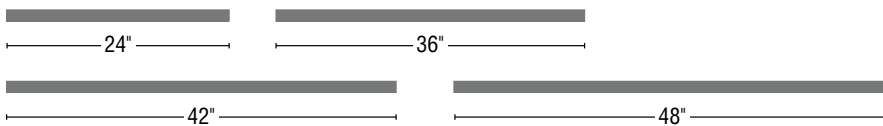

Nominal unit width: 24", 36", 42" or 48"
 actual beaded post unit width is the nominal width plus 1" +1/16", - 0". Actual high rise post unit width is the nominal width plus 2" +1/16", -0". Actual angle post unit width is the nominal width ±1/16", - 0".

DEPTHS

Borroughs steel shelving comes in seven standard depths from 12" to 36" for efficient storage of a variety of items. Maximize your facility and stock picking efficiency with the optimum depth shelving.

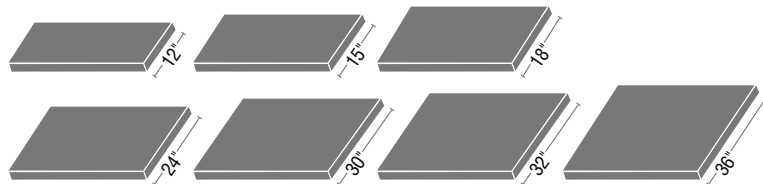

Nominal depth: 12", 15", 18", 24", 30", 32" or 36" is nominal depth plus +1/2", - 0". With beaded and/or high rise post in front and angle post in back. Actual angle post front and back, unit depth is the nominal depth +1/32", - 0".

LENGTH OF RUN

Actual length of beaded post shelving run is nominal unit width +1/16" , - 0" per unit plus 1/2" for each row end.
 Actual length of angle post shelving run is nominal unit width +1/16" , - 0" per unit. Actual high rise post shelving run is nominal unit width +2" , -0" per unit plus 1" for each row end.

CLEAR SHELF OPENING

Actual clear opening between beaded posts is the nominal width minus 1". Actual clear opening between angle posts is the nominal width minus 2". Vertical clearance between shelves is equal to center-to-center shelf spacing minus 1 7/32".

VERTICAL ADJUSTMENT

All shelves are adjustable on 1 1/2" centers.

BUILDING YOUR SHELVING

STEPS TO BUILDING A SUCCESSFUL SHELF SYSTEM

1. What will be stored on the shelves? This is a critical factor in the success of making sure your system supports your needs.

2. What height do I need for my system? Will you want the maximum vertical height for a particular room, or is reaching the shelves from the ground an important factor?

3. How wide & how deep do I need my shelves? The proper depth and width of the units will insure your materials are stored at maximum efficiency on the shelves, leaving no dead space.

4. Finally how many units do you need and do I need side panels or back panels to comply with fire codes, or to keep materials free from dirt and dust?

CHOOSE YOUR SHELF LOAD CAPACITY:

- P0 (24 gauge)
- P1 (22 gauge)
- P2 (20 gauge)
- P3 (18 gauge)

see page 9 for load capacities

ADD CROSS BRACES OR SIDE PANELS:

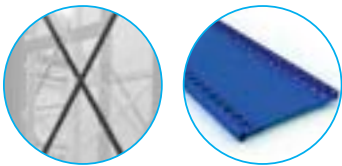

BE SURE TO ADD FOOTPLATES FOR POST WEIGHT DISTRIBUTION AND ANCHORING AND/OR SHIM PLATES FOR LEVELING



FOOTPLATE SHIM PLATES

CHOOSE YOUR POST:



ANGLE (GOOD)



BEADED (BETTER)



HIGH-RISE (BEST)

DETERMINE THE WIDTH AND DEPTH OF THE SHELVES YOU NEED



OPEN & CLOSED UNITS

OPEN - TYPE UNITS



Borroughs flexible, open-type shelving consists of posts, shelves and sway braces for added stability. It is ideal for general purpose storage and meets most storage requirements while providing maximum efficiency.

CLOSED - TYPE UNITS (WITHOUT BACKS)



Closed-type shelving without backs provide side support, and give row ends a more finished appearance. Closed-type shelving without backs are often combined with closed units in back-to-back installations or used alone along walls.

36" Wide Units (WxDxH)		
Starter Unit	5 shelves	Adder Unit
1000-3	36" x 12" x 7'3"	1001-3
1004-3	36" x 18" x 7'3"	1005-3
1006-3	36" x 24" x 7'3"	1007-3
Starter Unit	5 shelves	Adder Unit
1012-3	36" x 12" x 7'3"	1013-3
1016-3	36" x 18" x 7'3"	1017-3
1018-3	36" x 24" x 7'3"	1019-3
Starter Unit	7 shelves	Adder Unit
1024-3	36" x 12" x 7'3"	1025-3
1028-3	36" x 18" x 7'3"	1029-3
1030-3	36" x 24" x 7'3"	1031-3
Starter Unit	8 shelves	Adder Unit
1036-3	36" x 12" x 7'3"	1037-3
1040-3	36" x 18" x 7'3"	1041-3
1042-3	36" x 24" x 7'3"	1043-3

36" Wide Units (WxDxH)		
Starter Unit	5 shelves	Adder Unit
2000-3	36" x 12" x 7'3"	2001-3
2004-3	36" x 18" x 7'3"	2005-3
2006-3	36" x 24" x 7'3"	2007-3
Starter Unit	5 shelves	Adder Unit
2012-3	36" x 12" x 7'3"	2013-3
2016-3	36" x 18" x 7'3"	2017-3
2018-3	36" x 24" x 7'3"	2019-3
Starter Unit	7 shelves	Adder Unit
2024-3	36" x 12" x 7'3"	2025-3
2028-3	36" x 18" x 7'3"	2029-3
2030-3	36" x 24" x 7'3"	2031-3
Starter Unit	8 shelves	Adder Unit
2036-3	36" x 12" x 7'3"	2037-3
2040-3	36" x 18" x 7'3"	2041-3
2042-3	36" x 24" x 7'3"	2043-3

48" Wide Units (WxDxH)		
Starter Unit	5 shelves	Adder Unit
1000-4	48" x 12" x 7'3"	1001-4
1004-4	48" x 18" x 7'3"	1005-4
1006-4	48" x 24" x 7'3"	1007-4
Starter Unit	6 shelves	Adder Unit
1012-4	48" x 12" x 7'3"	1013-4
1016-4	48" x 18" x 7'3"	1017-4
1018-4	48" x 24" x 7'3"	1019-4
Starter Unit	7 shelves	Adder Unit
1024-4	48" x 12" x 7'3"	1025-4
1028-4	48" x 18" x 7'3"	1029-4
1030-4	48" x 24" x 7'3"	1031-4
Starter Unit	8 shelves	Adder Unit
1036-4	48" x 12" x 7'3"	1037-4
1040-4	48" x 18" x 7'3"	1041-4
1042-4	48" x 24" x 7'3"	1043-4

48" Wide Units (WxDxH)		
Starter Unit	5 shelves	Adder Unit
2000-4	48" x 12" x 7'3"	2001-4
2004-4	48" x 18" x 7'3"	2005-4
2006-4	48" x 24" x 7'3"	2007-4
Starter Unit	6 shelves	Adder Unit
2012-4	48" x 12" x 7'3"	2013-4
2016-4	48" x 18" x 7'3"	2017-4
2018-4	48" x 24" x 7'3"	2019-4
Starter Unit	7 shelves	Adder Unit
2024-4	48" x 12" x 7'3"	2025-4
2028-4	48" x 18" x 7'3"	2029-4
2030-4	48" x 24" x 7'3"	2031-4
Starter Unit	8 shelves	Adder Unit
2036-4	48" x 12" x 7'3"	2037-4
2040-4	48" x 18" x 7'3"	2041-4
2042-4	48" x 24" x 7'3"	2043-4

OPEN & CLOSED UNITS

CLOSED - TYPE UNITS (WITH BACKS)



This Borroughs shelving type is enclosed on the back and sides to protect the contents, while providing a neat, finished appearance. Closed-type shelving is perfect for storing loose parts. Backs come standard in #445 White.

ADDER UNITS EXPLAINED

Adder units share a closed or open side to make up a double unit. Allowing for a shared panel and saving money in the process.

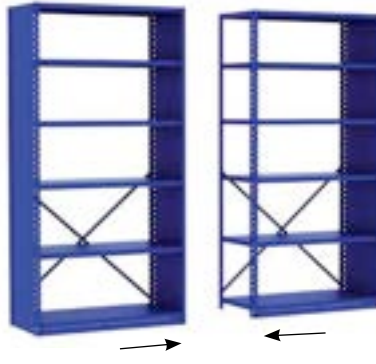

Here an **Angle Post** is shown sharing the closed side. The adder unit still has a front and back post along the shared side.

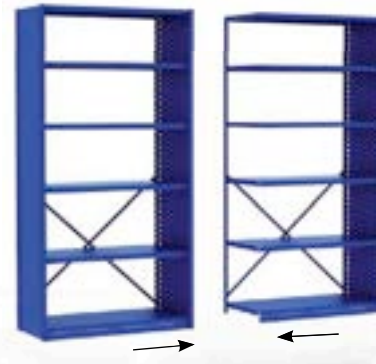

Here a **Beaded Post** shares the closed side. This configuration shares the starter units front Beaded post which can accept clips on either side.

36" Wide Units (WxDxH)

Starter Unit	5 shelves	Adder Unit
3000-3	36" x 12" x 7'3"	3001-3
3004-3	36" x 18" x 7'3"	3005-3
3006-3	36" x 24" x 7'3"	3007-3
Starter Unit	5 shelves	Adder Unit
3012-3	36" x 12" x 7'3"	3013-3
3016-3	36" x 18" x 7'3"	3017-3
3018-3	36" x 24" x 7'3"	3019-3
Starter Unit	7 shelves	Adder Unit
3024-3	36" x 12" x 7'3"	3025-3
3028-3	36" x 18" x 7'3"	3029-3
3030-3	36" x 24" x 7'3"	3031-3
Starter Unit	8 shelves	Adder Unit
3036-3	36" x 12" x 7'3"	3037-3
3040-3	36" x 18" x 7'3"	3041-3
3042-3	36" x 24" x 7'3"	3043-3

48" Wide Units (WxDxH)

Starter Unit	5 shelves	Adder Unit
3000-4	48" x 12" x 7'3"	3001-4
3004-4	48" x 18" x 7'3"	3005-4
3006-4	48" x 24" x 7'3"	3007-4
Starter Unit	6 shelves	Adder Unit
3012-4	48" x 12" x 7'3"	3013-4
3016-4	48" x 18" x 7'3"	3017-4
3018-4	48" x 24" x 7'3"	3019-4
Starter Unit	7 shelves	Adder Unit
3024-4	48" x 12" x 7'3"	3025-4
3028-4	48" x 18" x 7'3"	3029-4
3030-4	48" x 24" x 7'3"	3031-4
Starter Unit	8 shelves	Adder Unit
3036-4	48" x 12" x 7'3"	3037-4
3040-4	48" x 18" x 7'3"	3041-4
3042-4	48" x 24" x 7'3"	3043-4

BIN-TYPE UNITS

Literally thousands of bin configurations can be designed from the Borroughs basic bin unit. Shown here are just a few of our most popular units. With Borroughs versatile bin-type shelving, you can have a storage system precisely customized to store your parts and small bulk items.

Shelf dividers and boxes separate items for easy access and identification. Backs come painted #445 white to reflect light in the unit, reducing picking time and errors.

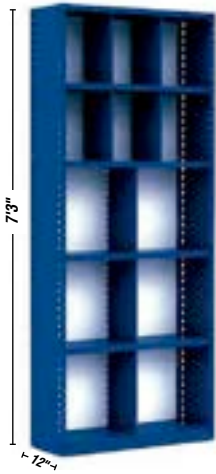
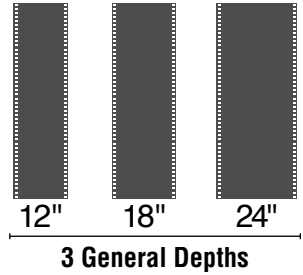

Starter Part#	W x D x H	Adder Unit
4012	36" x 12" x 7'3"	4013
4016	36" x 18" x 7'3"	4017
4018	36" x 24" x 7'3"	4019
Configurations		
6 Bins	12"w x 15"h	
6 Bins	18"w x 18"h	



Starter Part#	W x D x H	Adder Part#
4148	36" x 12" x 7'3"	4149
4152	36" x 18" x 7'3"	4153
4154	36" x 24" x 7'3"	4155
Configurations		
8 Bins	8"w x 9"h, 1 1/2" high bin fronts	
2 Bins	8"w x 12"h, 3" high bin fronts	
8 Bins	10"w x 9"h, 1 1/2" high bin fronts	
2 Bins	10"w x 12"h, 3" high bin fronts	
9 Bins	12"w x 12"h, 3" high bin fronts	



Starter Part#	W x D x H	Adder Unit
4036	36" x 12" x 7'3"	4037
4040	36" x 18" x 7'3"	4041
4042	36" x 24" x 7'3"	4043
Configurations		
21 Bins	12"w x 12"h	



Starter Part#	W x D x H	Adder Part#
4172	36" x 12" x 7'3"	4173
4176	36" x 18" x 7'3"	4177
4178	36" x 24" x 7'3"	4179
Configurations		
2 Bins	18"w x 9"h, 1 1/2" high bin fronts	
24 Bins	6"w x 6"h, 1 1/2" high bin fronts	
6 Bins	10"w x 9"h, 1 1/2" high bin fronts	
6 Bins	8"w x 9"h, 1 1/2" high bin fronts	
6 Bins	12"w x 12"h, 3" high bin fronts	

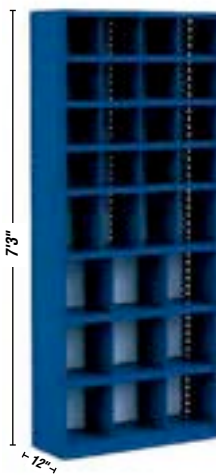

Starter Part#	W x D x H	Adder Unit
4048	36" x 12" x 7'3"	4049
4052	36" x 18" x 7'3"	4053
4054	36" x 24" x 7'3"	4055
Configurations		
8 Bins	8"w x 9"h	
8 Bins	10"w x 9"h	
2 Bins	8"w x 12"h	
2 Bins	10"w x 12"h	
9 Bins	12"w x 12"h	



Starter Part#	W x D x H	Adder Part#
4184	36" x 12" x 7'3"	4185
4188	36" x 18" x 7'3"	4189
4190	36" x 24" x 7'3"	4191
Configurations		
84 Bins	6"w x 6"h, 1 1/2" high bin fronts	

COUNTER-TYPE UNITS

Service counters offer convenient storage space at the point of personal contact. Open and closed units can be ordered. Closed units come with #445 white backs to reflect light in the unit, increasing picking accuracy.

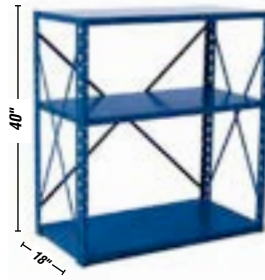

Note: All units come standard with Plus 2 shelves, unless otherwise stated.



OPEN UNITS

Starter Part#	W x D x H	Adder Part#
36" WIDE UNITS		
7018	36" x 18" x 40"	7019
7024	36" x 24" x 40"	7025
7030	36" x 30" x 40"	7031
42" WIDE UNITS		
7118	42" x 18" x 40"	7119
7124	42" x 24" x 40"	7125
7130	42" x 30" x 40"	7131

CLOSED UNITS

Starter Part#	W x D x H	Adder Part#
36" WIDE UNITS		
7518	36" x 18" x 40"	7519
7524	36" x 24" x 40"	7525
7530	36" x 30" x 40"	7531
42" WIDE UNITS		
7618	42" x 18" x 40"	7619
7624	42" x 24" x 40"	7625
7630	42" x 30" x 40"	7631



POSTS



13
GAUGE
STEEL

ANGLE POSTS

Angle Posts are 2¹/₄" x 1" and come in 17 standard heights, punched with rectangular holes on 1¹/₂" centers for shelf positioning and have round holes on 1¹/₂" centers for the attachment of accessories. In addition, each post has an offset formed into the side flange for added strength and for shelf bracket clearance.

PART #	HEIGHT	PART #	HEIGHT
09534-099	3'3"	09534-093	9'3"
09534-098	4'3"	09534-092	10'3"
09534-097	5'3"	09534-091	11'3"
09534-096	6'3"	09534-090	12'3"
13112-099	7'0"	09534-089	13'3"
09534-095	7'3"	09534-088	14'3"
13112-096	8'0"	09534-087	15'3"
09534-094	8'3"	09534-086	16'3"



14
GAUGE
STEEL

BEADED POSTS

This post is designed for use in the front position to provide additional clear shelf space and a wider shelf opening. 2³/₄" x 1" in height, standard heights with a rear flange that is spot-welded on 6" centers for added strength. Posts are punched with rectangular holes on 1¹/₂" centers for shelf positioning, and with round holes on 1¹/₂" centers for the attachment of accessories and have an off-set formed into the side flange for added strength and for shelf bracket clearance.

PART #	HEIGHT	PART #	HEIGHT
14933-000	6'3"	14933-004	10'3"
14933-001	7'3"	14933-008	12'3"
14933-002	8'3"	14993-009	14'3"
14933-003	9'3"	14933-010	16'3"



14
GAUGE
STEEL

HIGH-RISE POSTS

The Box-Tee design is the heart of the high rise system. High-Rise Posts are 2³/₄" x 2", and were developed by Borroughs engineers to allow maximum strength in a post compatible with the extensive line of accessories available from Borroughs. The result of this design effort is a post available in lengths up to 20' – an industry exclusive.

PART #	HEIGHT
14917-000	7'3"
14917-001	8'3"
14917-002	9'3"
14917-003	10'3"
14917-004	12'3"
14917-005	15'3"
14917-006	16'3"

CLOSED SIDES



24
GAUGE
STEEL

CLOSED
SIDE
STEEL

13
GAUGE
STEEL

POST
STEEL

ANGLE POSTS-CLOSED SIDES

Angle Posts—Closed Sides form a partition to the floor to enclose the side of a unit. They are often used to finish off the end of a row of open-type shelving and provide front-to-back stability. The addition of two angle posts will provide an intermediate closed side at minimum cost.

PART #	W x H	PART #	W x H
09608-098	12" x 3'3"	09608-035	18" x 15'3"
09608-091	12" x 4'3"	09608-025	18" x 16'3"
09608-077	12" x 6'3"	09608-095	24" x 3'3"
09608-070	12" x 7'3"	09608-088	24" x 4'3"
09608-063	12" x 8'3"	09608-081	24" x 5'3"
09608-056	12" x 9'3"	09608-074	24" x 6'3"
09608-049	12" x 10'3"	09608-067	24" x 7'3"
09608-039	12" x 13'3"	09608-060	24" x 8'3"
09608-027	12" x 16'3"	09608-053	24" x 9'3"
09608-097	15" x 3'3"	09608-046	24" x 10'3"
09608-076	15" x 6'3"	09608-042	24" x 11'3"
09608-069	15" x 7'3"	09608-040	24" x 12'3"
09608-062	15" x 8'3"	09608-038	24" x 13'3"
09608-055	15" x 9'3"	09608-036	24" x 14'3"
09608-048	15" x 10'3"	09608-034	24" x 15'3"
09608-096	18" x 3'3"	09608-024	24" x 16'3"
09680-089	18" x 4'3"	09608-094	30" x 3'3"
09608-082	18" x 5'3"	09608-087	30" x 4'3"
09608-075	18" x 6'3"	09608-066	30" x 7'3"
09608-068	18" x 7'3"	09608-059	30" x 8'3"
09608-061	18" x 8'3"	09608-045	30" x 10'3"
09608-054	18" x 9'3"	09608-072	36" x 6'3"
09608-047	18" x 10'3"	09608-065	36" x 7'3"
09608-043	18" x 11'3"	09608-058	36" x 8'3"
09608-041	18" x 12'3"	09608-044	36" x 10'3"
09608-039	18" x 13'3"	09608-022	36" x 16'3"
09608-037	18" x 14'3"		

• Additional sizes available on request.



24
GAUGE
STEEL

CLOSED
SIDE
STEEL

14
GAUGE
STEEL

POST
STEEL

BEADED POSTS-CLOSED SIDES

Beaded Posts—Closed Sides are used to finish off the end of a row of open-type shelving. The addition of an angle post bolted to the rear post will provide an intermediate closed side at minimal cost.

PART #	W x H	PART #	W x H
14938-000	12" x 6'3"	14938-020	18" x 9'3"
14938-006	12" x 7'3"	14938-026	18" x 10'3"
14938-012	12" x 8'3"	14938-003	24" x 6'3"
14938-018	12" x 9'3"	14938-009	24" x 7'3"
14938-024	12" x 10'3"	14938-015	24" x 8'3"
14938-001	15" x 6'3"	14938-021	24" x 9'3"
14938-007	15" x 7'3"	14938-027	24" x 10'3"
14938-013	15" x 8'3"	14938-010	30" x 7'3"
14938-025	15" x 10'3"	14938-016	30" x 8'3"
14938-002	18" x 6'3"	14938-022	30" x 9'3"
14938-008	18" x 7'3"	14938-028	30" x 10'3"
14938-014	18" x 8'3"		

CLOSED SIDES



HIGH-RISE POSTS-CLOSED SIDES

Used to finish off the end of a row of open-type shelving. The addition of an angle post bolted to the rear post will provide an intermediate closed side at minimal cost.



PART #	W x H	PART #	W x H	PART #	W x H
14970-017	12" x 7'3"	14970-052	18" x 14'3"	14970-040	30" x 11'3"
14970-022	12" x 8'3"	14970-057	18" x 15'3"	14970-045	30" x 12'3"
14970-027	12" x 9'3"	14970-062	18" x 16'3"	14970-050	30" x 13'3"
14970-032	12" x 10'3"	14970-019	24" x 7'3"	14970-055	30" x 14'3"
14970-037	12" x 11'3"	14970-024	24" x 8'3"	14970-060	30" x 15'3"
14970-042	12" x 12'3"	14970-029	24" x 9'3"	14970-065	30" x 16'3"
14970-047	12" x 13'3"	14970-034	24" x 10'3"	14970-021	36" x 7'3"
14970-052	12" x 14'3"	14970-039	24" x 11'3"	14970-026	36" x 8'3"
14970-057	12" x 15'3"	14970-044	24" x 12'3"	14970-031	36" x 9'3"
14970-062	12" x 16'3"	14970-049	24" x 13'3"	14970-036	36" x 10'3"
14970-018	18" x 7'3"	14970-054	24" x 14'3"	14970-041	36" x 11'3"
14970-023	18" x 8'3"	14970-059	24" x 15'3"	14970-046	36" x 12'3"
14970-028	18" x 9'3"	14970-064	24" x 16'3"	14970-051	36" x 13'3"
14970-033	18" x 10'3"	14970-020	30" x 7'3"	14970-056	36" x 14'3"
14970-038	18" x 11'3"	14970-025	30" x 8'3"	14970-061	36" x 15'3"
14970-043	18" x 12'3"	14970-030	30" x 9'3"	14970-066	36" x 16'3"
14970-048	18" x 13'3"	14970-035	30" x 10'3"		

FOOT PLATE - FRONT

Provides two 3/8" diameter holes for floor bolts, as well as a single hole for locating shim plates.



PART #	Description
14952-000	Front

SHIM PLATE - FRONT

Matched to foot plate with centering dimple and provides matching holes for floor-anchoring installations.



PART #	Description
14951-000	Front



FOOT PLATE - BACK-TO-BACK

Provides for floor anchoring with two 3/8" diameter holes for floor bolts as well as a single centering hole for locating shim plates.



PART #	Description
14953-000	Back-to-Back

SHIM PLATE - BACK-TO-BACK

Match to back-to-back foot plate with centering dimple and provides matching holes for floor-anchoring.



PART #	Description
14949-000	Back-to-Back

HEAVY-DUTY FOOT PLATE

2-bolt foot plate, used to anchor posts to the floor for seismic applications.



PART #	Description
11076-000	Front
11079-000	Back to Back

BACKS & BRACES

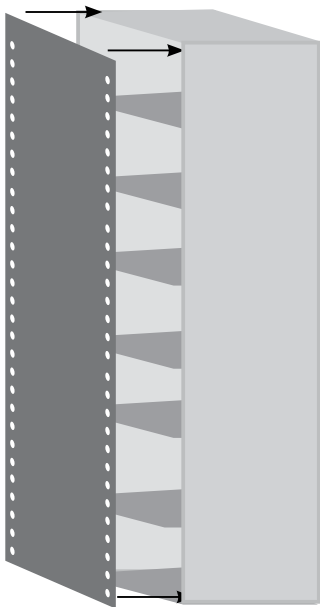

22
GAUGE
STEEL

SHELVING BACKS

Made of 24 gauge cold-rolled steel. For heights over 8'3", use combinations of smaller sizes, overlapped in the middle, with a minimum of a 1" inch overlap. Bolted to unit every 18" (typically).

PART #	W x H	PART #	W x H
09551-099	24" x 7'3"	09550-096	42" x 6'3"
09547-097	36" x 3'3"	09551-096	42" x 7'3"
09548-097	36" x 4'3"	14867-096	42" x 8'3"
09549-097	36" x 5'3"	09547-095	48" x 3'3"
09550-097	36" x 6'3"	09548-095	48" x 4'3"
09551-097	36" x 7'3"	09549-095	48" x 5'3"
14867-097	36" x 8'3"	09550-095	48" x 6'3"
09547-096	42" x 3'3"	09551-095	48" x 7'3"
09548-096	42" x 4'3"	14867-095	48" x 8'3"
09549-096	42" x 5'3"		



CROSS BRACES (BACK & SIDES)

3/4" banded steel cross braces add structural rigidity to open-type units. Available for sides and backs. All cross braces attach on 30" vertical centers and are bolted in center.

12
GAUGE
STEEL

PART #	LENGTH	Description
13826-000	24"	Back Brace
13828-000	36"	Back Brace
05017-815	42"	Back Brace
05165-815	48"	Back Brace
05019-815	12"	Side Brace
05583-815	15"	Side Brace
05020-815	18"	Side Brace
13829-000	24"	Side Brace
13830-000	30"	Side Brace
10445-000	32"	Side Brace
13831-000	36"	Side Brace



ANGLE POST FACE BRACE

Often used when units must be accessible from front and back, precluding the use of back cross braces. Furnished in pairs for both angle and beaded posts.

11
GAUGE
STEEL

PART #
10462-000

BEADED POST FACE BRACE



11
GAUGE
STEEL

PART #
10463-000

SHELVES

Borroughs' Box Edge Plus shelf is designed for additional value and aesthetics without additional investment. The front and rear edges of the shelf are formed into a closed, welded box shape that, along with the lapped and welded corners, give the shelf maximum strength and rigidity. Plus, the box edge provides additional strength to handle impact or point loads. The Box Edge Plus shelf also has a cleaner, more attractive front edge and is fully compatible with all existing Borroughs' shelf brackets and posts. All shelves are punched on 1" centers for shelf dividers, except for 42" x 32" which have no divider holes. Four shelf support brackets are provided for each shelf. **(09531-099)**

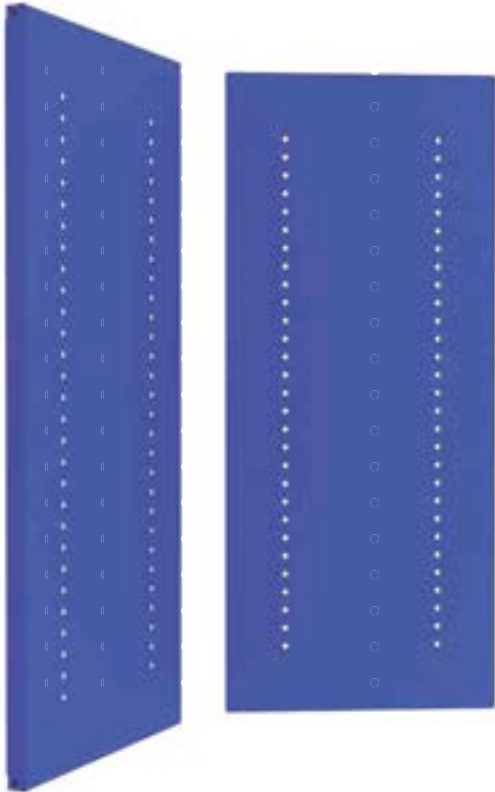

Size W x D	Box Edge Plus 0 (24 g.)	Box Edge Plus 1 (22 g.)	Box Edge Plus 2 (20 g.)	Box Edge Plus 3 (18 g.)
24" x 12"	–	10437-000	–	–
36" x 12"	10448-001	10437-001	10428-001	10419-001
42" x 12"	–	–	10428-002	10419-002
48" x 12"	10448-004	10437-003	10428-003	10419-003
36" x 15"	–	10446-001	10429-001	10420-001
42" x 15"	–	–	10429-002	10420-002
48" x 15"	–	–	10429-003	10420-003
24" x 18"	–	10439-000	–	–
36" x 18"	10448-002	10439-001	10430-001	10421-001
42" x 18"	–	10439-002	10430-002	10421-002
48" x 18"	10448-005	10439-003	10430-003	10421-003
24" x 24"	–	10441-000	–	–
36" x 24"	10448-003	10441-001	10432-001	10423-001
42" x 24"	–	–	10432-002	10423-002
48" x 24"	10448-006	10441-003	10432-003	10423-003
36" x 30"	–	–	10434-001	10425-001
42" x 30"	–	–	10434-002	10425-002
48" x 30"	–	–	10434-003	10425-003
42" x 32"	–	–	10435-002	10426-002
36" x 36"	–	–	10436-001	10427-001
42" x 36"	–	–	10436-002	10427-002
48" x 36"	–	–	10436-003	10427-003

BOX EDGE SHELF LOCK

Prevents shelf from lifting up due to prying action from below when boxes are extended. Locks shelf in place to allow transport of setup units.



PART #
08703-823

BOX EDGE SHELF CLIP

Non-binding, saddle-type brackets let you install and later adjust shelves quickly and easily, without disturbing other shelves. Provides twice the support area of other shelf supports.



PART #
09531-099

BOX EDGE HARDWARE

Unless otherwise stated, hardware is included in the part number and will be shipped along with the product. Borroughs uses only Grade 5 bolts for all bolted, structural connections.



DIVIDERS

FIXED SHELF DIVIDERS

Flanged at top, bottom and back for added strength - shelf dividers provide a rigid partition between compartments. Front edge has a 3/8" bead for extra rigidity and to protect hands. Attaches with push stud fasteners (included). For additional fasteners use part number **47955-01**.



PART #	D x H	PART #	D x H
05599-807	12" x 6"	14374-000	18" x 16 ¹ / ₂ "
05606-807	12" x 9"	05629-807	18" x 18"
05613-807	12" x 12"	05643-807	18" x 24"
05620-807	12" x 15"	05602-807	24" x 6"
05627-807	12" x 18"	05609-807	24" x 9"
05600-807	15" x 6"	05616-807	24" x 12"
05607-807	15" x 9"	05623-807	24" x 15"
05614-807	15" x 12"	05630-807	24" x 18"
05621-807	15" x 15"	05637-807	24" x 21"
05628-807	15" x 18"	05644-807	24" x 24"
05601-807	18" x 6"	05604-807	36" x 6"
05608-807	18" x 9"	05611-807	36" x 9"
05615-807	18" x 12"	05618-807	36" x 12"
05622-807	18" x 15"		

SLIDING SHELF DIVIDERS

Snaps into place over front and rear shelf flanges. Holds position firmly yet slides easily along the shelf to allow spacing changes to be made quickly. Features a formed in label holder that travels with the divider when parts are rearranged.



PART #	D x H
14745-000	12" x 4 ¹ / ₂ "
14745-004	12" x 6"
14745-001	15" x 4 ¹ / ₂ "
14745-005	15" x 6"
14745-002	18" x 4 ¹ / ₂ "
14745-006	18" x 6"
14745-003	24" x 4 ¹ / ₂ "
14745-007	24" x 6"

ANGLE SHELF DIVIDERS

Flanged at bottom and punched for attachment to shelves. Attaches with push studs, adjustable on 2" centers.



PART #	D x H
05490-842	12" x 1 ¹ / ₂ "
05493-842	12" x 3"
05492-842	18" x 1 ¹ / ₂ "
05495-842	18" x 3"

SHELF SADDLE REINFORCEMENTS

Extending from side to side under center portion of shelf. Held in place by side flanges of the shelf, this piece reinforces the shelf center and must be used with shelf side supports.

PART #	WIDTH
09610-097	36"
09610-096	42"
09610-095	48"

SHELF SIDE SUPPORTS

Used when shelf saddle is used in conjunction with shelf brackets. Shelf rests on top flange. May also be used as a base strip on ends of rows of open shelving.



PART #	LENGTH
09555-098	12"
09555-096	18"
09555-095	24"
09555-094	30"
09555-093	36"



BOXES & BIN FRONTS

SHELF BOXES

Sides are slotted at 1" intervals to receive partitions. Face has hand pull and label holder. Protective backstop prevents accidental removal of box from shelf. All shelf boxes are 4^{5/8}" high. Partitions are not included with shelf boxes. A shelf lock should be used on shelves immediately above boxes.



PART #	W x D	PART #	W x D
05339-808	5 ^{9/16} " x 11"	05353-808	11" x 17"
05345-808	8 ^{3/8} " x 11"	05342-808	5 ^{9/16} " x 23"
05351-808	11" x 11"	05349-808	8 ^{3/8} " x 23"
05325-808	5 ^{9/16} " x 17"	05355-808	11" x 23"
05347-808	8 ^{3/8} " x 17"		

PARTITIONS FOR SHELF

BOX (DIVIDERS)

Partitions accept 7/8" labels. All partitions are 4^{5/8}" high. Not included with shelf boxes.



PART #	HEIGHT
05476-810	5"
05477-810	8"
05478-810	11"

BOX GUIDES

Prevents shelf box from lodging behind front flange of post. Extends 5" back from front flange of post. Recommended when using shelf boxes and front angle posts.



PART #
09559-099



Scan this QR Code to download *Box-Edge* installation instructions

ANGLE POST BIN FRONTS

Used on front of shelves to keep items within the bin, made of 18 gauge steel except angle posts 1^{1/2}" and 3" which are 22 gauge. All bin fronts have a 1/2" bead on top and bottom edges. Clips provided for 1^{1/2}" angle post bin front. Bolts provided for all others.

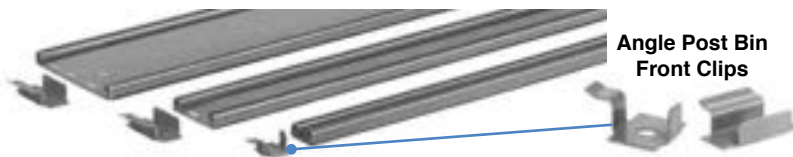

PART #	W x H	PART #	W x H
05698-819	36" x 1 ^{1/2} "	09557-096	42" x 3"
05701-819	42" x 1 ^{1/2} "	09557-095	48" x 3"
05704-819	48" x 1 ^{1/2} "	09558-097	36" x 6"
09557-099	24" x 3"	09558-096	42" x 6"
09557-097	36" x 3"	09558-095	48" x 6"

ANGLE POST BIN FRONT CLIPS (SEE IMAGE BOTTOM LEFT)

PART #	Size
05707-835	1 ^{1/2} "
05708-836	3" and 6"

BEADED POST BIN FRONTS

Used on front of shelves to keep items within the bin.



PART #	W x H
09615-097	36" x 1 ^{1/2} "
09616-097	36" x 3"

ACCESSORIES

BASE STRIPS

Used to fill in the space between the bottom shelf and the floor. Prevents dirt/debris from getting under the unit.

Angle Post Strip



22
GAUGE
STEEL

PART #	LENGTH
09554-099	24"
09554-097	36"
09554-096	42"
09554-095	48"

Beaded Post Strip



22
GAUGE
STEEL

PART #	LENGTH
09614-097	36"
09614-096	42"
09614-095	48"



LABEL HOLDERS

Black plastic - comes with label holder fasteners. Holds standard 7/8" high labels. For additional fastener use part number **47955-00**.



PART #	LENGTH
09656-099	24"
09656-097	36"
09656-096	42"
09656-095	48"

MAGNETIC LABEL HOLDER

48" magnetic label holder. Holds standard 7/8" labels and can be easily cut to any length.



PART #	W x H
10460-000	48" x 1"

BOLTLESS HANG BARS

Boltless hang bar kit includes rod and two special supports that fasten to posts of shelving unit. 48" rods can be field cut for 42" width.



PART #	W x D
10140-000	24" x 18"
10140-004	24" x 24"
10140-001	36" x 18"
10140-005	36" x 24"
10140-002	48" x 18"
10140-006	48" x 24"

LONG PARTS FRAMES

Offer ideal vertical storage of long parts and materials such as molding, pipes and bar stock. Adjust up and down within shelving on 1 1/2" centers. Fit open or closed shelving, 36" wide. Spacer rods are designed so as not to dislodge during removal of material. Adjust horizontally on 1 1/2" centers. Label holders can be attached to either the top or front face of the frame.

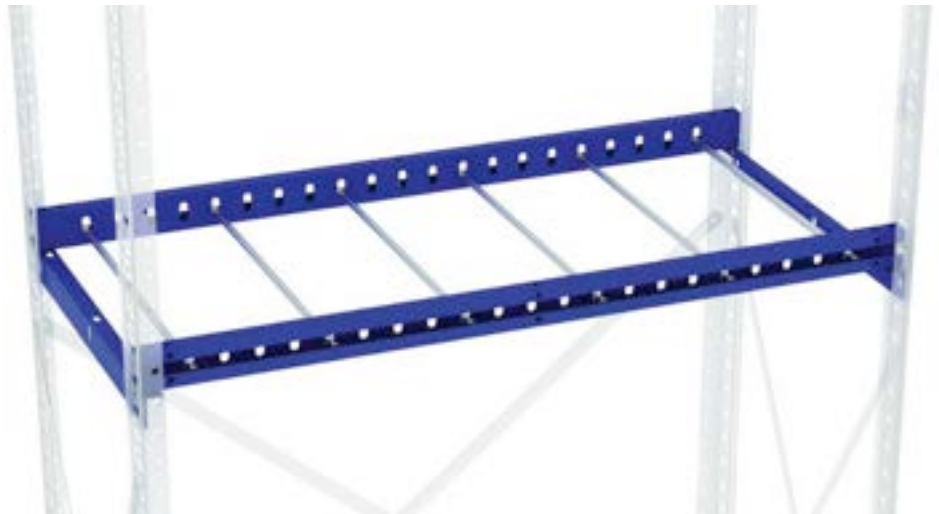

18
GAUGE
STEEL

FRAMES		RODS	
PART #	W x D	PART #	Length
09576-099	36" x 12"	06238-860	12"
09576-098	36" x 18"	06239-860	18"
09576-097	36" x 24"	06240-860	24"

POST SPLICERS

Used to combine two posts. Often used to add on to the vertical size of an existing installation or when heights greater than 20' (tallest one-piece post in the industry) are required.

CORNER SPLICER

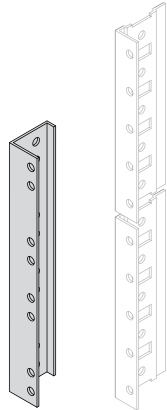

Fig. 1
on next page

13
GAUGE
STEEL

PART #	DESCRIPTION
09545-099	Corner Splicer

INTERMEDIATE SPLICE BAR



Fig. 3
on next page

10
GAUGE
STEEL

PART #	DESCRIPTION
09365-000	Intermediate Splicer Bar (Quantity 1)

SPLICER PLATE (SINGLE ROW INTERMEDIATE)

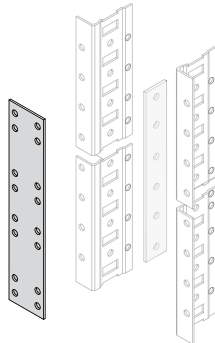

Fig. 2
on next page

13
GAUGE
STEEL

PART #	DESCRIPTION
09366-000	Splicer Plate (Quantity 1)

ROW END BACK-TO-BACK SPLICE CONFIGURATION



Fig. 4
on next page

10
GAUGE
STEEL

PART #	DESCRIPTION
09365-000	Splicer Bar (Quantity 1)

HIGH-RISE POST SPLICER KIT

Provides front-to-back as well as lateral support. High-rise posts are joined with eight self-drilling screws and four bolts with the upper post resting on a 1/4" steel support plate. This system produces a splice internal to the high-rise post resulting in a neat, finished appearance.

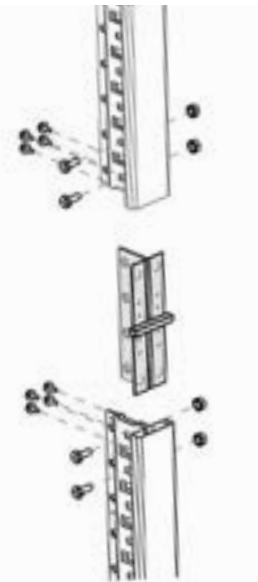

PART #	SPLICE KIT
14928-000	High-Rise Post Splicer Kit

BEADED POST SPLICER KIT

The beaded post splicer consists of a 1/4" steel plate at right angles to a 1" front plate which is attached with self-threading screws. Also includes splicer bar.



Fig. 5
on next page

10
GAUGE
STEEL

PART #	SPLICE KIT
14934-000	Beaded Post Splicer

CATWALK BEAMS

Channel beams require no brackets, attach directly to post. Designed to give maximum load bearing capabilities. Beams are available for angle and beaded posts, in four lengths. Supports decking at same height as mezzanine bracket and beam.



Angle Post

12
GAUGE
STEEL

OR

14
GAUGE
STEEL



Beaded Post

ANGLE POSTS		BEADED POSTS	
PART #	WIDTH	PART #	WIDTH
10135-000	30"	10134-000	30"
10135-001	36"	10134-001	36"
10135-002	42"	10134-002	42"
10135-003	48"	10134-003	48"

ANGLE POST CORNER SPLICERS

CORNER SPLICE, FIGURE 1

Corner Splice to be used on single row shelving row ends utilizing Angle Post. The Splice mechanically attaches to front and side flanges of the post, giving support in two directions.

SPLICE PLATE AND BAR, FIGURE 2

Splice Plate and Bar to be used in all shelving utilizing Angle Post in intermediate locations. Intermediate Splice Bar is used between two angle post sides in conjunction with the Splice Plate on the front of two angle post side-by-side.

SPLICE BAR/INTERMEDIATE BAR FIGURE 3

10 gauge bar to be used with Beaded Post, High-Rise Post and Angle Post at all splice locations. Figure 3 showing Back-to-Back shelving Intermediate location (4 required per location) Bar to be mechanically attached.

PART #	Description
09545-099	Corner Splicer
09365-000	Splicer Bar
09366-000	Splicer Plate

Fig. 1 Corner Splicer

Fig. 2 Splice Plate & Bar

Fig. 3 Intermediate Splice Bar

Fig. 4 Row End Back to Back

Fig. 5 Beaded Post Slice Kit

Each Splice Bar, Splice Plate and/or Corner Splice MUST BE ORDERED separately. Each Part# includes only one each except where noted by a KIT.

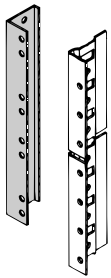

Fig. 1

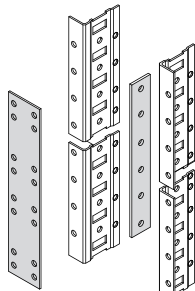

Fig. 2



Fig. 3



Fig. 4

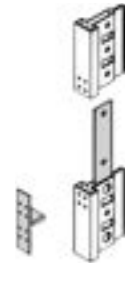
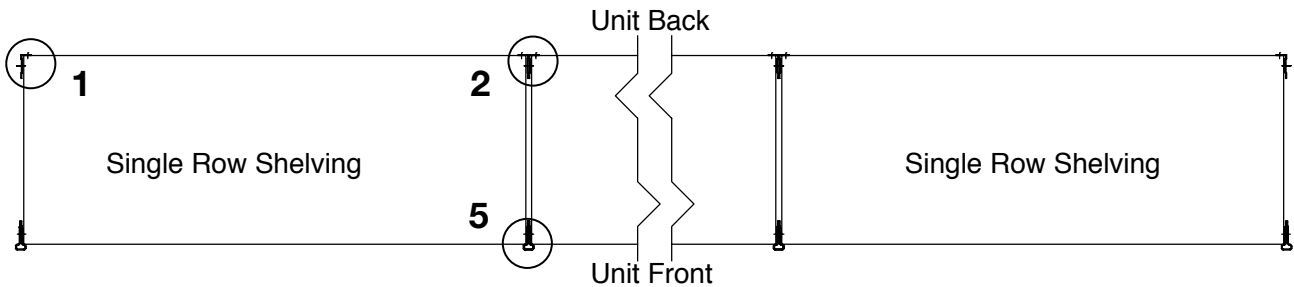
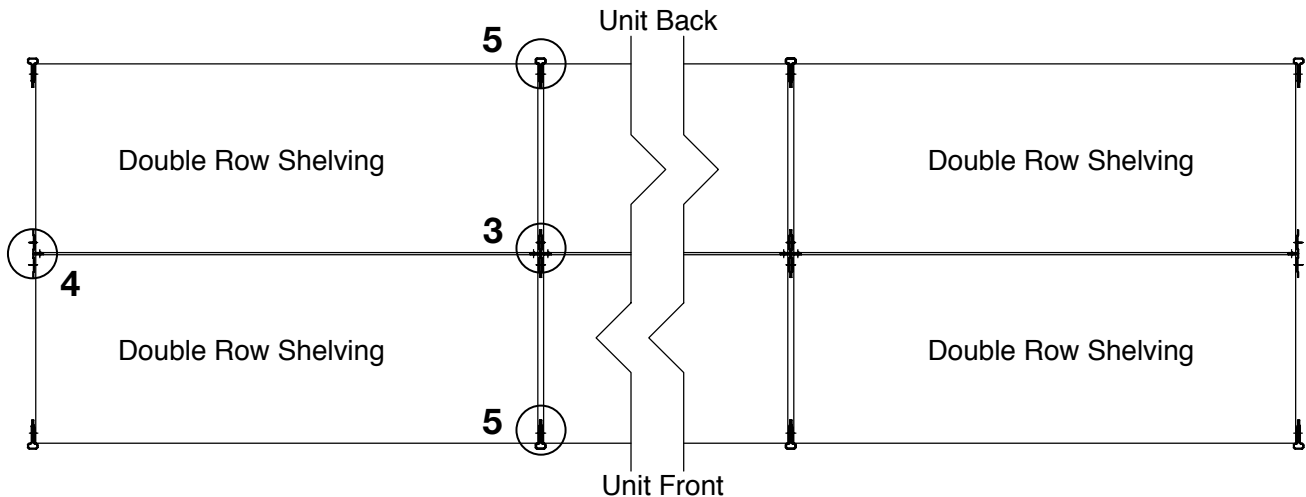

Fig. 5



Beaded Post units shown consisting of beaded post fronts and angle post backs





INSTALLATION EXAMPLES



Left: Box Edge Pick Modules for Boombah Sport Distribution Center.

Above: Box Edge Shelving with Perforated End Panels at Germain Lincoln, Naples,



Above: Box Edge with HD Drawers and Perforated End Panels at Germain Lexus, Naples, FL.

Above Right: Open Side, Open Back Box Edge Shelving for The City of Hamilton Records Storage.

Right: Box Edge Closed Sides, Closed Backs with HD Drawers and a Catwalk level for Cape Canaveral Air Force Station, Cape Canaveral, FL.



NECESSITIES & ACCESSORIES



20
GAUGE
STEEL

FRAMED DOORS

Swing-type doors for angle post shelving are made with a 3-point locking door handle. Doors consist of a fully contained welded steel frame, which bolts to the face of the unit simply and easily. Framed doors are available to fit shelving up to 7'3" tall. Two or more standard-sized doors are used for heights of 7'3". A special 4'0" high door is made for use above ledges. Doors will fit high density drawer units. Doors are not compatible with Beaded Post or Beaded Closed Sides. Adds 2^{1/16}" to depth of unit.

PART #	W x H	PART #	W x H
13402-001	36" x 3'3"	13402-002	42" x 3'3"
13404-001	36" x 4'0"	13402-014	42" x 6'3"
13402-005	36" x 4'3"	13402-018	42" x 7'3"
13402-013	36" x 6'3"	13402-003	48" x 3'3"
13402-017	36" x 7'3"	13402-015	48" x 6'3"
		13402-019	48" x 7'3"

A. 1 pr. 48" x 7'3" doors.

B. 1 pr. 36" x 3'3" doors, and 1 pr. 36" x 4' doors.

PRE-CONFIGURED CABINET TYPE UNITS

Fully enclosed cabinet-type shelving provides protection against dust and dirt. Backs come standard in #445 White. Doors lock for added security.

Note: All units come standard with Plus 2 shelves, unless otherwise stated.



Starter with:

- 4 Doors
- 6 Shelves
- 2 Closed sides
- 1 Base strip
- 1 Back

Adder with:

- 2 Doors
- 6 Shelves
- 1 Closed sides
- 1 Base strip
- 1 Back
- 2 Angle Posts

Starter Part#	W x D x H	Adder Part#
5012	36" x 12" x 7'3"	5013
5016	36" x 18" x 7'3"	5017
5018	36" x 24" x 7'3"	5019

Starter with:

- 2 Doors
- 6 Shelves
- 2 Closed sides
- 1 Base strip
- 1 Back

Adder with:

- 2 Doors
- 6 Shelves
- 1 Closed sides
- 1 Base strip
- 1 Back
- 2 Angle Posts

Starter Part#	W x D x H	Adder Part#
5112	36" x 12" x 7'3"	5113
5116	36" x 18" x 7'3"	5117
5118	36" x 24" x 7'3"	5119



NECESSITIES & ACCESSORIES



COUNTER BACKS

A 5/8" return flange, positioned inward at the bottom, provides additional stiffness. Backs also provides a finished look.

18
GAUGE
STEEL

PART #	W x H
09571-097	36" x 3'3"
09571-096	42" x 3'3"



16
GAUGE
STEEL

COUNTER TOPS

Counter top has a 1" overhang on both front and rear faces. Converts a 3'3" section of shelving into a durable, heavy-duty counter. Tops 36" x 24" or larger have a saddle reinforcement welded in for added strength.

PART #	W x D	PART #	W x D
09570-099	36" x 18"	09569-098	42" x 24"
09570-098	42" x 18"	09569-097	36" x 30"
09569-099	36" x 24"	09569-096	42" x 30"



16
GAUGE
STEEL

LEDGE TOPS

Ledge top front has a 5/8" lip for enhanced strength and appearance. One piece construction allows easy bolting to the top of ledge-type units. Sides attach to provide a finished appearance on a single unit or a flush joint with adjacent units.

PART #	W x D	PART #	W x D
09565-092	36" x 12"	09565-082	36" x 18"
09565-091	42" x 12"	09565-081	42" x 18"
09565-090	48" x 12"	09565-080	48" x 18"





BUILDING HIGH DENSITY DRAWERS IN A SHELVING SYSTEM

BUILDING A SUCCESSFUL HD DRAWER SYSTEM

1. What will you store in the drawers and on the shelves? In order to get the most efficient use of your storage system.
2. What is the size of my space, where I will be installing the HD Drawer system? A critical decision that effects the width and depth of your drawer & shelf system.

3. If I need multiple drawer systems, how many drawers do I need in each unit?
4. Finally, based on the what I am storing, can I utilize a "Pre-Configured" set of drawers or do I need to customize my interiors?

**NEW
HIGH DENSITY
DRAWERS**

CHOOSE YOUR SHELF LOAD CAPACITY:

- P0 (24 gauge)
- P1 (22 gauge)
- P2 (20 gauge)
- P3 (18 gauge)

ADD CROSS BRACES OR SIDE PANELS:

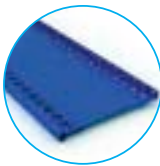

CHOOSE YOUR POST:



ANGLE



BEADED



HIGH-RISE



FOOTPLATE



SHIM PLATES

DETERMINE THE WIDTH AND DEPTH OF THE DRAWERS YOU NEED BASED ON NECESSARY AISLE WIDTH

BE SURE TO ADD FOOTPLATES FOR POST WEIGHT DISTRIBUTION AND ANCHORING AND/OR SHIMPLATES FOR LEVELING

HD DRAWERS, SIZES, AND SPECIFICATIONS

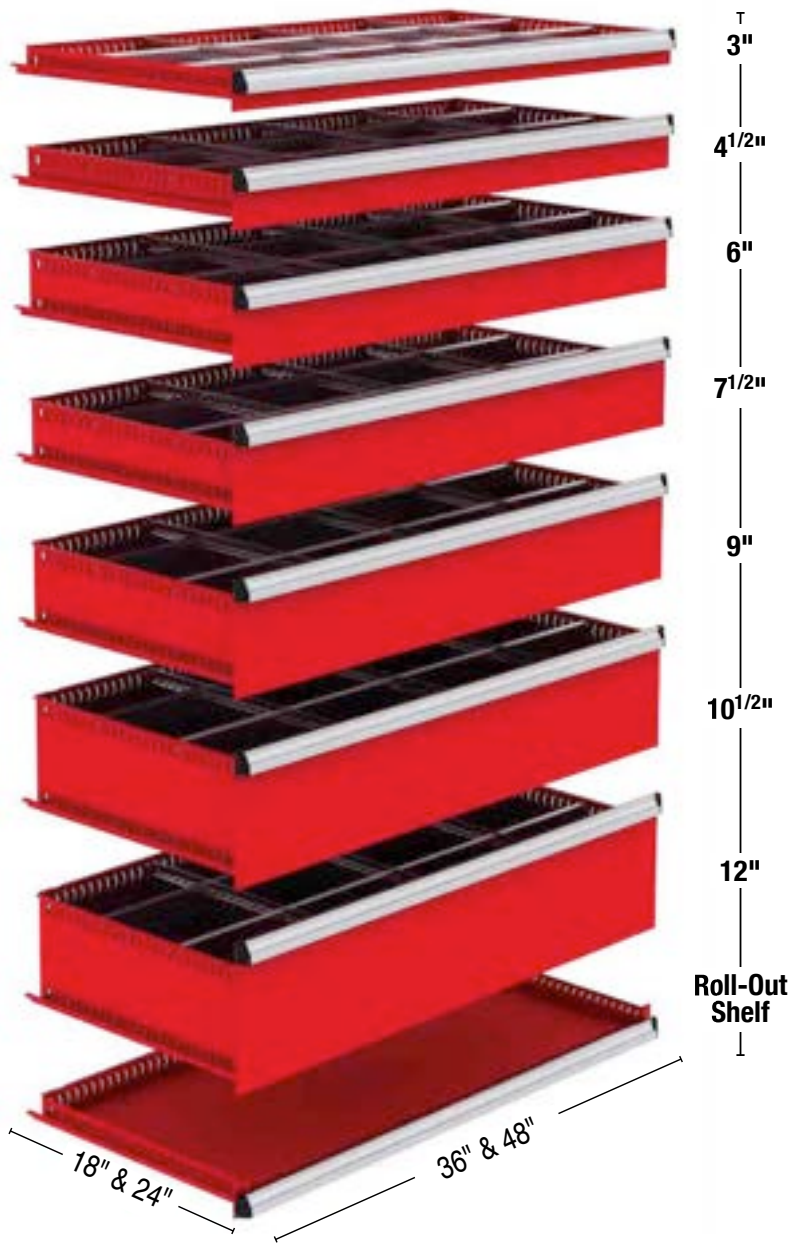

28 DRAWER SIZES

Drawers have 7 different heights: **3", 4 1/2", 6", 7 1/2", 9", 10 1/2", 12" and Roll-Out Shelf.** Drawers can be arranged and rearranged to keep your storage system efficient as your operation grows and changes. They can be installed in any combination as long as the total height of the drawer fronts does not exceed the height of the mounting upright panels.

FEATURES

- Drawers fully extend to view and access entire contents.
- Roller bearing suspension for smooth operation.
- Each drawer will support up to 400 pounds of an evenly distributed load.
- Partitions and dividers can be added for custom configuration.
- All hardware and easy-to follow instructions are provided for fast installation.
- Drawer dividers and partitions are galvanized steel & factory installed.

**NEW
HIGH DENSITY
DRAWERS**

Drawer Sizes	Drawer Front	Usable Height	Interior Clear Dimensions		Interior Clear Dimensions	
			36" x 18"	36" x 24"	48" x 18"	48" x 24"
3"	2 ¹⁵ / ₁₆ "	2 ¹ / ₆ "				
4 1/2"	4 ⁷ / ₁₆ "	3 ⁹ / ₁₆ "				
6"	5 ¹⁵ / ₁₆ "	5 ¹ / ₁₆ "	3.0 sq. ft.	4.3 sq. ft.	4.1 sq. ft.	6.0 sq. ft.
7 1/2"	7 ⁷ / ₁₆ "	6 ⁹ / ₁₆ "				
9"	8 ¹⁵ / ₁₆ "	8 ¹ / ₁₆ "				
10 1/2"	10 ⁷ / ₁₆ "	9 ⁹ / ₁₆ "				
12"	11 ¹⁵ / ₁₆ "	11 ¹ / ₁₆ "				

HD DRAWERS, COMPONENTS & ACCESSORIES

PRE-CONFIGURED DRAWERS

Borroughs offers a large number of standard pre-configured drawer interiors frequently ordered for small parts storage. For simplicity, these Borroughs' drawers and interiors can be ordered as a complete, outfitted assembly using only one part number. This provides the drawer, including the slide and handle/label holder, factory installed partitions with essential dividers packaged together. This makes ordering quick and easy...and saves installation time, too!



PARTITIONS

Galvanized, slotted steel partitions create major drawer interior storage spaces. Partitions slide into slots on drawer walls to span the full depth of drawers—and, allow the addition of dividers to further subdivide the drawer's interior.



DIVIDERS

Galvanized steel dividers subdivide the storage spaces between partitions or partitions and drawer walls. Dividers simply drop into slots in partitions and drawer walls making storage space adjustments quick and easy. Slots in partitions and drawer walls are on 20mm (3/4" nominal) centers. Divider widths are measured by the number of drawer wall slots the divider spans (i.e. a 4s divider will span 4 slots). Dividers are available in heights to match partitions and in 17 widths (refer to page 44). The 36" wide drawer has 39 slots and the 48" wide drawer has 54 slots.



HD DRAWERS – CONFIGURING YOUR SYSTEM

PRE-CONFIGURED DRAWER SYSTEM PART NUMBER LEGEND



Shelving not included.

Pre-Configured units come with: Mounting Upright Panels, Drawers, Slides, Partitions and Dividers (partitions and dividers are factory installed).

PRODUCT MODEL

D1 - 48 24 48 - 05 A L

DRAWER WIDTH

OPTIONS = 36, 48

DRAWER DEPTH

OPTIONS = 18, 24

DRAWER QUANTITY

MUST BE TWO (2) DIGIT NUMBER

DRAWER CONFIGURATION

A PRE-DETERMINED LETTER THAT DEFINES A SPECIFIC GROUPING OF DRAWERS AND INTERIORS

FRAME HEIGHT	
OPTION	SIZE
06	6"
12	12"
18	18"
24	24"
36	36"
48	48"

DRAWER INTERIORS	
OPTION	DESCRIPTION
E	EMPTY DRAWERS
L	PRE-DETERMINED INTERIORS (DIVIDERS & PARTITIONS FACTORY INSTALLED)



Mounting upright panel sets are available in 6 heights: **6", 12", 18", 24", 36" and 48"**.



Full-width aluminum handle features integral label holder and paper insert. Handles are flush with shelving.



400 lb. capacity roller bearing slides offer smooth operation with full drawer extension.

HD DRAWERS - MAXIMIZING SPACE

SPACE SAVINGS YOU SEE INSTANTLY

Thinking about building an addition to your current space? Choose high density storage and optimize your current space, and avoid additional costs.

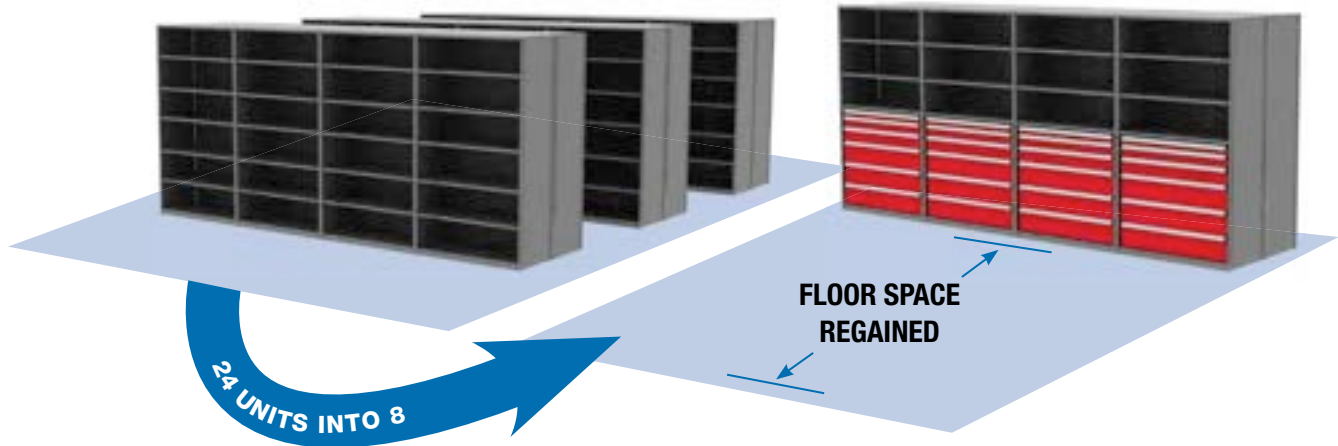

EASE OF ASSEMBLY

Borroughs HD Drawers in Shelving units assemble using simple tools in three easy steps

- 1 Attach the mounting brackets to the uprights
- 2 Attach the drawer rails to the mounting brackets
- 3 Insert suspension slides and drawers

The minimum space required for drawers depends on the height of the mounting brackets.

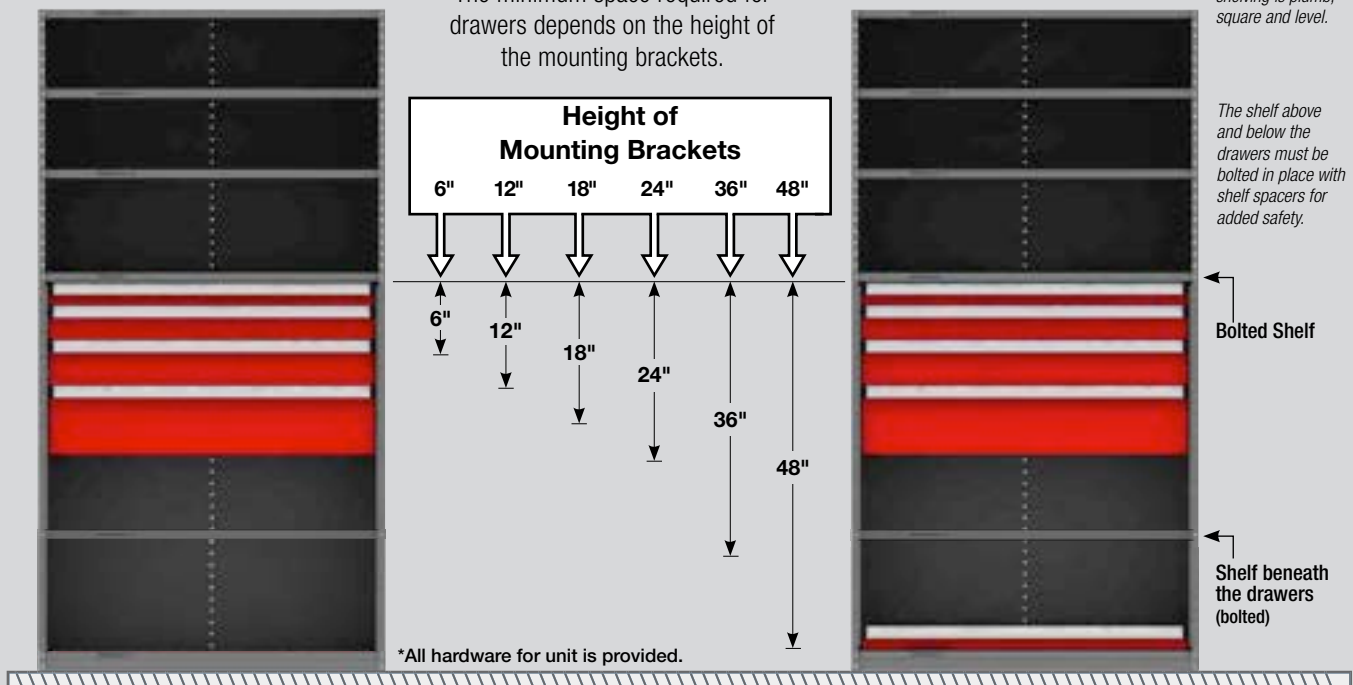

HD DRAWERS – PRE-CONFIGURED UNITS (DRAWER SYSTEM ONLY)

48" WIDE X 24" DEEP DRAWER SYSTEMS



D1-482448-10AL
 (2) 3" 0705
 (4) 4-1/2" 0705
 (4) 6" 1108

10 Drawers
 300 Compartments



D1-482448-09AL
 (2) 3" 0705
 (2) 4-1/2" 0705
 (4) 6" 1108
 (1) 9" 1313

9 Drawers
 228 Compartments



D1-482448-08AL
 (8) 6" 1108

8 Drawers
 120 Compartments



D1-482448-08BL
 (3) 3" 0705
 (2) 4-1/2" 0705
 (2) 6" 1108
 (1) Roll-Out

8 Drawers
 231 Compartments

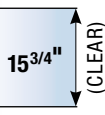

D1-482436-07AL
 (4) 4-1/2" 0705
 (3) 6" 1108

7 Drawers
 205 Compartments

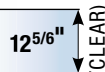

D1-482436-07BL
 (2) 3" 0705
 (2) 4-1/2" 0705
 (2) 6" 1108
 (1) 9" 1313

7 Drawers
 198 Compartments



D1-482424-05AL
 (4) 4-1/2" 0705
 (1) 6" 1108

5 Drawers
 175 Compartments

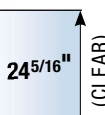

D1-482418-04AL
 (4) 4-1/2" 0705

4 Drawers
 160 Compartments

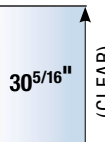

- Part numbers include: mounting upright panels, drawer(s), slides, partitions and dividers (partitions & dividers - factory installed).
- Drawer layouts can be found on page 41-43.



Scan this QR Code to download HD Drawer installation instructions

HD DRAWERS – PRE-CONFIGURED UNITS (DRAWER SYSTEM ONLY)

36" WIDE X 24" DEEP DRAWER SYSTEMS • Drawer layouts can be found on page 39-40.



D1-362448-10AL
 (2) 3" 0605
 (4) 4-1/2" 0605
 (4) 6" 1008

10 Drawers
 228 Compartments



D1-362448-08AL
 (8) 6" 1008

Top of Shelf
 52 1/4"
 (TYPICAL)
 Floor

8 Drawers
 96 Compartments



D1-362448-08BL
 (3) 3" 0605
 (2) 4-1/2" 0605
 (2) 6" 1008
 (1) Roll-Out

15 3/4"
 (CLEAR)

8 Drawers
 175 Compartments



D1-362436-07AL
 (4) 4-1/2" 0605
 (3) 6" 1008

7 Drawers
 216 Compartments

12 5/16"
 (CLEAR)



D1-362424-05AL
 (4) 4-1/2" 0605
 (1) 6" 1008

5 Drawers
 192 Compartments

24 5/16"
 (CLEAR)



D1-362418-04AL
 (4) 4-1/2" 0605

4 Drawers
 180 Compartments

30 5/16"
 (CLEAR)

36" WIDE X 18" DEEP DRAWER SYSTEMS • Drawer layouts can be found on page 38.



D1-361848-10AL
 (2) 3" 0604
 (4) 4-1/2" 0609
 (4) 6" 1009

10 Drawers
 176 Compartments



D1-361848-08AL
 (8) 6" 1009

8 Drawers
 64 Compartments



D1-361848-08BL
 (3) 3" 0604
 (2) 4-1/2" 0609
 (2) 6" 1009
 (1) Roll-Out

15 3/4"
 (CLEAR)

8 Drawers
 137 Compartments

PRE-CONFIGURED 36"W X 18"D DRAWER INTERIORS

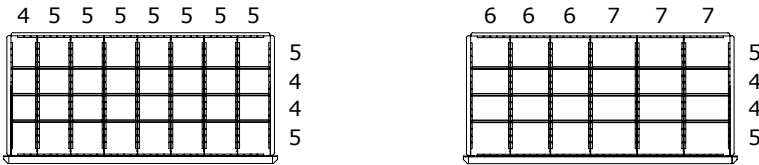

40 Compartments

D1-3618030-0504	3"
D1-3618045-0504	4-1/2"
D1-3618060-0504	6"
D1-3618075-0504	7-1/2"
D1-3618090-0504	9"
D1-3618105-0504	10-1/2"
D1-3618120-0504	12"

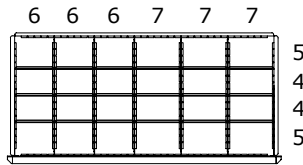

24 Compartments

D1-3618030-0604	3"
D1-3618045-0604	4-1/2"
D1-3618060-0604	6"
D1-3618075-0604	7-1/2"
D1-3618090-0604	9"
D1-3618105-0604	10-1/2"
D1-3618120-0604	12"

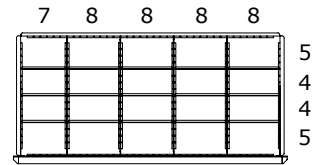

20 Compartments

D1-3618030-0804	3"
D1-3618045-0804	4-1/2"
D1-3618060-0804	6"
D1-3618075-0804	7-1/2"
D1-3618090-0804	9"
D1-3618105-0804	10-1/2"
D1-3618120-0804	12"

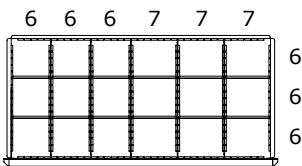

18 Compartments

D1-3618030-0606	3"
D1-3618045-0606	4-1/2"
D1-3618060-0606	6"
D1-3618075-0606	7-1/2"
D1-3618090-0606	9"
D1-3618105-0606	10-1/2"
D1-3618120-0606	12"

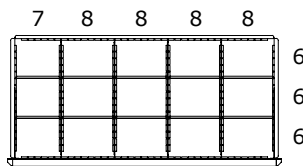

15 Compartments

D1-3618030-0806	3"
D1-3618045-0806	4-1/2"
D1-3618060-0806	6"
D1-3618075-0806	7-1/2"
D1-3618090-0806	9"
D1-3618105-0806	10-1/2"
D1-3618120-0806	12"

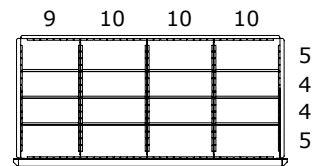

16 Compartments

D1-3618030-1004	3"
D1-3618045-1004	4-1/2"
D1-3618060-1004	6"
D1-3618075-1004	7-1/2"
D1-3618090-1004	9"
D1-3618105-1004	10-1/2"
D1-3618120-1004	12"

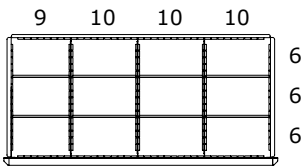

12 Compartments

D1-3618030-1006	3"
D1-3618045-1006	4-1/2"
D1-3618060-1006	6"
D1-3618075-1006	7-1/2"
D1-3618090-1006	9"
D1-3618105-1006	10-1/2"
D1-3618120-1006	12"

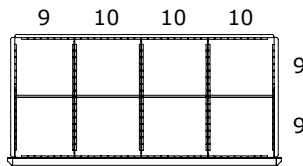

8 Compartments

D1-3618030-1009	3"
D1-3618045-1009	4-1/2"
D1-3618060-1009	6"
D1-3618075-1009	7-1/2"
D1-3618090-1009	9"
D1-3618105-1009	10-1/2"
D1-3618120-1009	12"

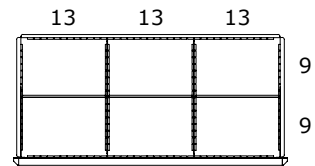

6 Compartments

D1-3618030-1309	3"
D1-3618045-1309	4-1/2"
D1-3618060-1309	6"
D1-3618075-1309	7-1/2"
D1-3618090-1309	9"
D1-3618105-1309	10-1/2"
D1-3618120-1309	12"

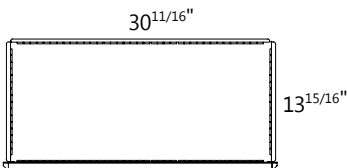

1 Compartment

D1-3618030-0000	3"
D1-3618045-0000	4-1/2"
D1-3618060-0000	6"
D1-3618075-0000	7-1/2"
D1-3618090-0000	9"
D1-3618105-0000	10-1/2"
D1-3618120-0000	12"

• Part numbers include: drawer(s), slides, partitions and dividers (partitions & dividers - factory installed).

PRE-CONFIGURED 36"W X 24"D DRAWER INTERIORS

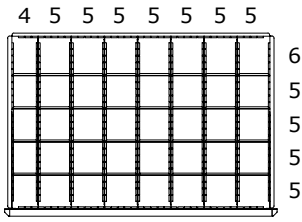

40 Compartments

D1-3624030-0505	3"
D1-3624045-0505	4-1/2"
D1-3624060-0505	6"
D1-3624075-0505	7-1/2"
D1-3624090-0505	9"
D1-3624105-0505	10-1/2"
D1-3624120-0505	12"

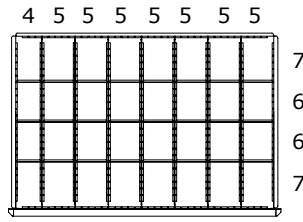

32 Compartments

D1-3624030-0506	3"
D1-3624045-0506	4-1/2"
D1-3624060-0506	6"
D1-3624075-0506	7-1/2"
D1-3624090-0506	9"
D1-3624105-0506	10-1/2"
D1-3624120-0506	12"

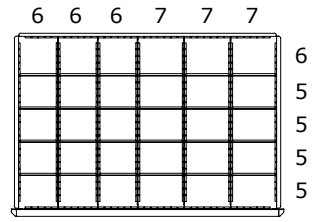

30 Compartments

D1-3624030-0605	3"
D1-3624045-0605	4-1/2"
D1-3624060-0605	6"
D1-3624075-0605	7-1/2"
D1-3624090-0605	9"
D1-3624105-0605	10-1/2"
D1-3624120-0605	12"

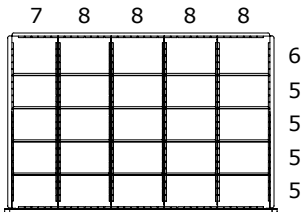

25 Compartments

D1-3624030-0805	3"
D1-3624045-0805	4-1/2"
D1-3624060-0805	6"
D1-3624075-0805	7-1/2"
D1-3624090-0805	9"
D1-3624105-0805	10-1/2"
D1-3624120-0805	12"

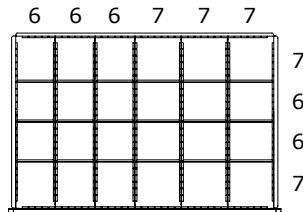

24 Compartments

D1-3624030-0606	3"
D1-3624045-0606	4-1/2"
D1-3624060-0606	6"
D1-3624075-0606	7-1/2"
D1-3624090-0606	9"
D1-3624105-0606	10-1/2"
D1-3624120-0606	12"

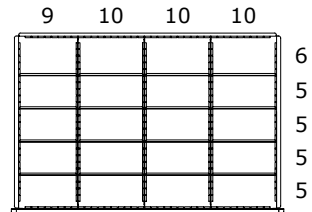

20 Compartments

D1-3624030-1005	3"
D1-3624045-1005	4-1/2"
D1-3624060-1005	6"
D1-3624075-1005	7-1/2"
D1-3624090-1005	9"
D1-3624105-1005	10-1/2"
D1-3624120-1005	12"

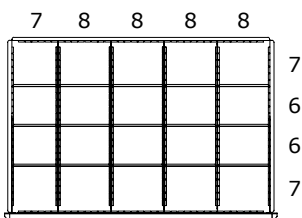

20 Compartments

D1-3624030-0806	3"
D1-3624045-0806	4-1/2"
D1-3624060-0806	6"
D1-3624075-0806	7-1/2"
D1-3624090-0806	9"
D1-3624105-0806	10-1/2"
D1-3624120-0806	12"

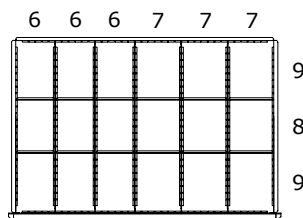

18 Compartments

D1-3624030-0608	3"
D1-3624045-0608	4-1/2"
D1-3624060-0608	6"
D1-3624075-0608	7-1/2"
D1-3624090-0608	9"
D1-3624105-0608	10-1/2"
D1-3624120-0608	12"

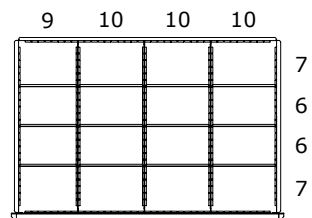

16 Compartments

D1-3624030-1006	3"
D1-3624045-1006	4-1/2"
D1-3624060-1006	6"
D1-3624075-1006	7-1/2"
D1-3624090-1006	9"
D1-3624105-1006	10-1/2"
D1-3624120-1006	12"

- Part numbers include: drawer(s), slides, partitions and dividers (partitions & dividers - factory installed).

Compartment Size	3	4	5	6	7	8	9	10	11	12	13	14
Dimension (Clear)	1 7/8"	2 11/16"	3 1/2"	4 1/4"	5 1/16"	5 7/8"	6 11/16"	7 1/2"	8 1/4"	9 1/16"	9 7/8"	10 11/16"

PRE-CONFIGURED 36"W X 24"D DRAWER INTERIORS

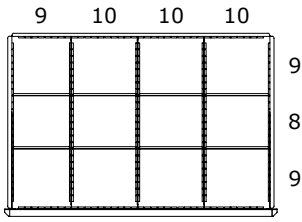

12 Compartments

D1-3624030-1008	3"
D1-3624045-1008	4-1/2"
D1-3624060-1008	6"
D1-3624075-1008	7-1/2"
D1-3624090-1008	9"
D1-3624105-1008	10-1/2"
D1-3624120-1008	12"

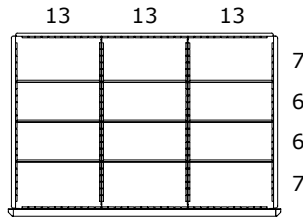

12 Compartments

D1-3624030-1306	3"
D1-3624045-1306	4-1/2"
D1-3624060-1306	6"
D1-3624075-1306	7-1/2"
D1-3624090-1306	9"
D1-3624105-1306	10-1/2"
D1-3624120-1306	12"

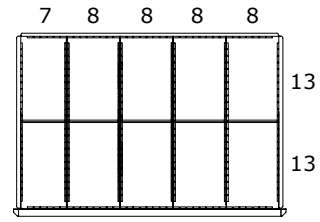

10 Compartments

D1-3624030-0813	3"
D1-3624045-0813	4-1/2"
D1-3624060-0813	6"
D1-3624075-0813	7-1/2"
D1-3624090-0813	9"
D1-3624105-0813	10-1/2"
D1-3624120-0813	12"

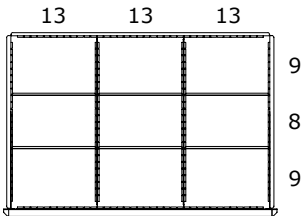

9 Compartments

D1-3624030-1308	3"
D1-3624045-1308	4-1/2"
D1-3624060-1308	6"
D1-3624075-1308	7-1/2"
D1-3624090-1308	9"
D1-3624105-1308	10-1/2"
D1-3624120-1308	12"

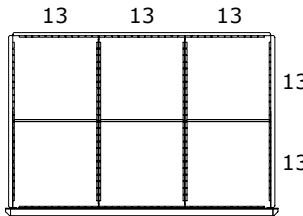

6 Compartments

D1-3624030-1313	3"
D1-3624045-1313	4-1/2"
D1-3624060-1313	6"
D1-3624075-1313	7-1/2"
D1-3624090-1313	9"
D1-3624105-1313	10-1/2"
D1-3624120-1313	12"

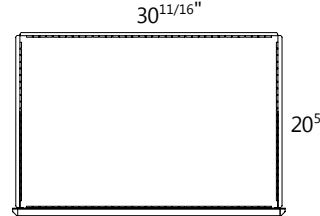

1 Compartment

D1-3624030-0000	3"
D1-3624045-0000	4-1/2"
D1-3624060-0000	6"
D1-3624075-0000	7-1/2"
D1-3624090-0000	9"
D1-3624105-0000	10-1/2"
D1-3624120-0000	12"

Compartment Size	3	4	5	6	7	8	9	10	11	12	13	14
Dimension (Clear)	1 7/8"	2 11/16"	3 1/2"	4 1/4"	5 1/16"	5 7/8"	6 11/16"	7 1/2"	8 1/4"	9 1/16"	9 7/8"	10 11/16"

• Part numbers include: drawer(s), slides, partitions and dividers (partitions & dividers - factory installed).



Left: Box Edge with HD Drawers at McKinney Mercedes, McKinney, TX.

PRE-CONFIGURED 48"W X 18"D DRAWER INTERIORS

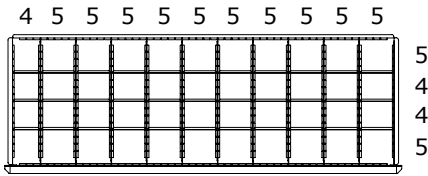

44 Compartments

D1-4818030-0504	3"
D1-4818045-0504	4-1/2"
D1-4818060-0504	6"
D1-4818075-0504	7-1/2"
D1-4818090-0504	9"
D1-4818105-0504	10-1/2"
D1-4818120-0504	12"

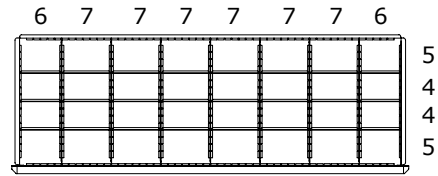

32 Compartments

D1-4818030-0704	3"
D1-4818045-0704	4-1/2"
D1-4818060-0704	6"
D1-4818075-0704	7-1/2"
D1-4818090-0704	9"
D1-4818105-0704	10-1/2"
D1-4818120-0704	12"

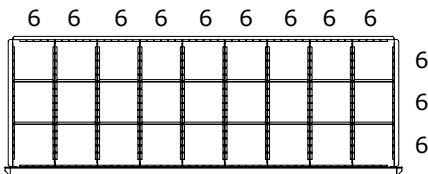

36 Compartments

D1-4818030-0606	3"
D1-4818045-0606	4-1/2"
D1-4818060-0606	6"
D1-4818075-0606	7-1/2"
D1-4818090-0606	9"
D1-4818105-0606	10-1/2"
D1-4818120-0606	12"

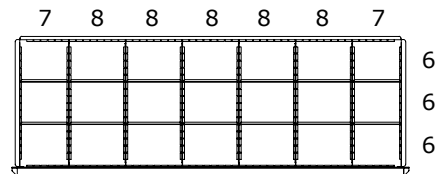

21 Compartments

D1-4818030-0806	3"
D1-4818045-0806	4-1/2"
D1-4818060-0806	6"
D1-4818075-0806	7-1/2"
D1-4818090-0806	9"
D1-4818105-0806	10-1/2"
D1-4818120-0806	12"

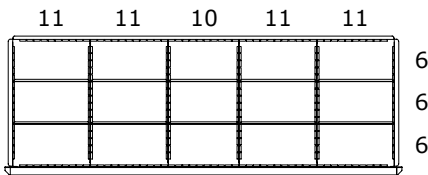

15 Compartments

D1-4818030-1106	3"
D1-4818045-1106	4-1/2"
D1-4818060-1106	6"
D1-4818075-1106	7-1/2"
D1-4818090-1106	9"
D1-4818105-1106	10-1/2"
D1-4818120-1106	12"

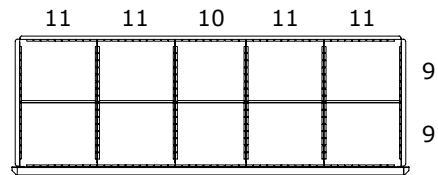

10 Compartments

D1-4818030-1109	3"
D1-4818045-1109	4-1/2"
D1-4818060-1109	6"
D1-4818075-1109	7-1/2"
D1-4818090-1109	9"
D1-4818105-1109	10-1/2"
D1-4818120-1109	12"

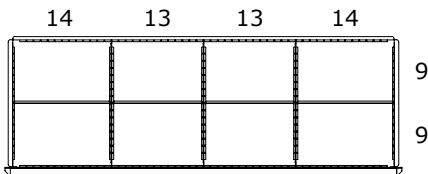

8 Compartments

D1-4818030-1309	3"
D1-4818045-1309	4-1/2"
D1-4818060-1309	6"
D1-4818075-1309	7-1/2"
D1-4818090-1309	9"
D1-4818105-1309	10-1/2"
D1-4818120-1309	12"

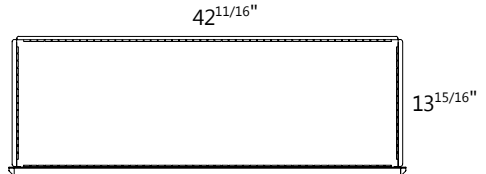

1 Compartment

D1-4818030-0000	3"
D1-4818045-0000	4-1/2"
D1-4818060-0000	6"
D1-4818075-0000	7-1/2"
D1-4818090-0000	9"
D1-4818105-0000	10-1/2"
D1-4818120-0000	12"

PRE-CONFIGURED 48"W X 24"D DRAWER INTERIORS

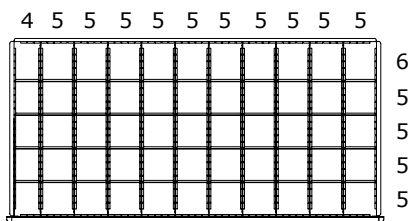

55 Compartments

D1-4824030-0505	3"
D1-4824045-0505	4-1/2"
D1-4824060-0505	6"
D1-4824075-0505	7-1/2"
D1-4824090-0505	9"
D1-4824105-0505	10-1/2"
D1-4824120-0505	12"

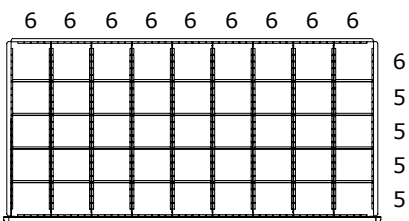

45 Compartments

D1-4824030-0605	3"
D1-4824045-0605	4-1/2"
D1-4824060-0605	6"
D1-4824075-0605	7-1/2"
D1-4824090-0605	9"
D1-4824105-0605	10-1/2"
D1-4824120-0605	12"

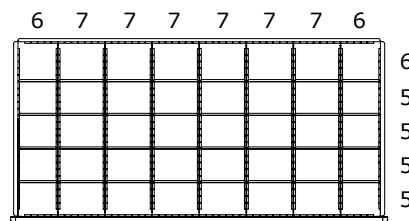

40 Compartments

D1-4824030-0705	3"
D1-4824045-0705	4-1/2"
D1-4824060-0705	6"
D1-4824075-0705	7-1/2"
D1-4824090-0705	9"
D1-4824105-0705	10-1/2"
D1-4824120-0705	12"

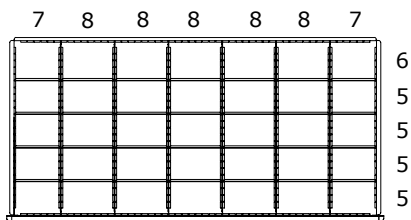

35 Compartments

D1-4824030-0805	3"
D1-4824045-0805	4-1/2"
D1-4824060-0805	6"
D1-4824075-0805	7-1/2"
D1-4824090-0805	9"
D1-4824105-0805	10-1/2"
D1-4824120-0805	12"

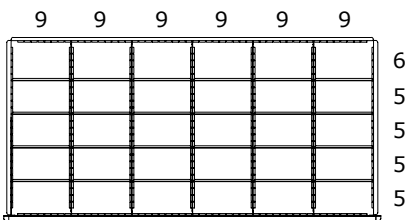

30 Compartments

D1-4824030-0905	3"
D1-4824045-0905	4-1/2"
D1-4824060-0905	6"
D1-4824075-0905	7-1/2"
D1-4824090-0905	9"
D1-4824105-0905	10-1/2"
D1-4824120-0905	12"

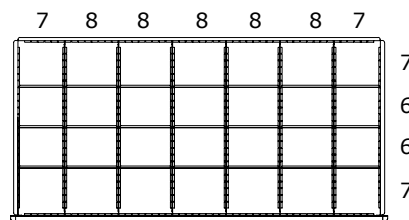

28 Compartments

D1-4824030-0806	3"
D1-4824045-0806	4-1/2"
D1-4824060-0806	6"
D1-4824075-0806	7-1/2"
D1-4824090-0806	9"
D1-4824105-0806	10-1/2"
D1-4824120-0806	12"

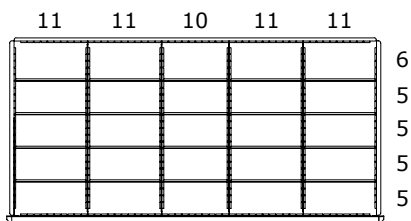

25 Compartments

D1-4824030-1105	3"
D1-4824045-1105	4-1/2"
D1-4824060-1105	6"
D1-4824075-1105	7-1/2"
D1-4824090-1105	9"
D1-4824105-1105	10-1/2"
D1-4824120-1105	12"

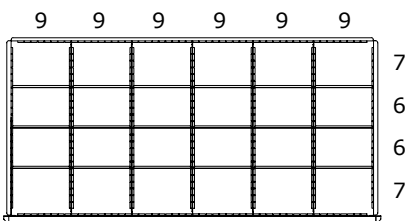

24 Compartments

D1-4824030-0906	3"
D1-4824045-0906	4-1/2"
D1-4824060-0906	6"
D1-4824075-0906	7-1/2"
D1-4824090-0906	9"
D1-4824105-0906	10-1/2"
D1-4824120-0906	12"

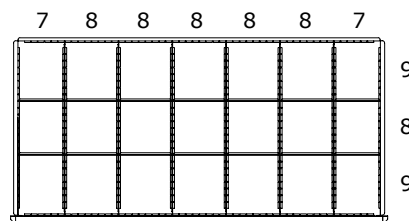

21 Compartments

D1-4824030-0808	3"
D1-4824045-0808	4-1/2"
D1-4824060-0808	6"
D1-4824075-0808	7-1/2"
D1-4824090-0808	9"
D1-4824105-0808	10-1/2"
D1-4824120-0808	12"

• Part numbers include: drawer(s), slides, partitions and dividers (partitions & dividers - factory installed).

Compartment Size	3	4	5	6	7	8	9	10	11	12	13	14
Dimension (Clear)	1 7/8"	2 11/16"	3 1/2"	4 1/4"	5 1/16"	5 7/8"	6 11/16"	7 1/2"	8 1/4"	9 1/16"	9 7/8"	10 11/16"

PRE-CONFIGURED 48"W X 24"D DRAWER INTERIORS

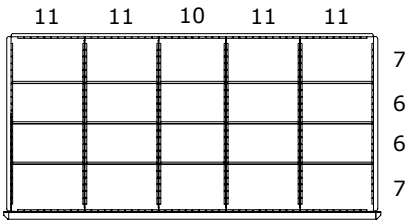

20 Compartments

D1-4824030-1106	3"
D1-4824045-1106	4-1/2"
D1-4824060-1106	6"
D1-4824075-1106	7-1/2"
D1-4824090-1106	9"
D1-4824105-1106	10-1/2"
D1-4824120-1106	12"

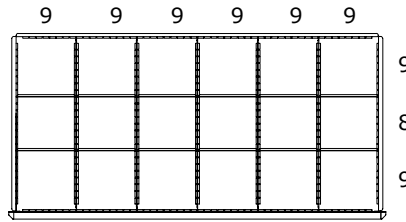

18 Compartments

D1-4824030-0908	3"
D1-4824045-0908	4-1/2"
D1-4824060-0908	6"
D1-4824075-0908	7-1/2"
D1-4824090-0908	9"
D1-4824105-0908	10-1/2"
D1-4824120-0908	12"

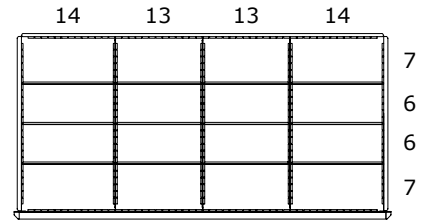

16 Compartments

D1-4824030-1306	3"
D1-4824045-1306	4-1/2"
D1-4824060-1306	6"
D1-4824075-1306	7-1/2"
D1-4824090-1306	9"
D1-4824105-1306	10-1/2"
D1-4824120-1306	12"

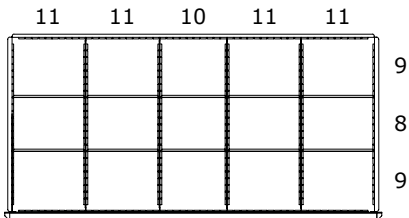

15 Compartments

D1-4824030-1108	3"
D1-4824045-1108	4-1/2"
D1-4824060-1108	6"
D1-4824075-1108	7-1/2"
D1-4824090-1108	9"
D1-4824105-1108	10-1/2"
D1-4824120-1108	12"

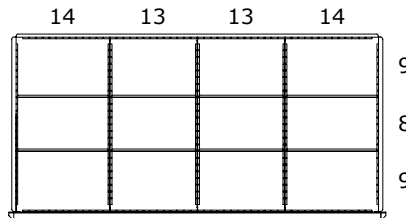

12 Compartments

D1-4824030-1308	3"
D1-4824045-1308	4-1/2"
D1-4824060-1308	6"
D1-4824075-1308	7-1/2"
D1-4824090-1308	9"
D1-4824105-1308	10-1/2"
D1-4824120-1308	12"

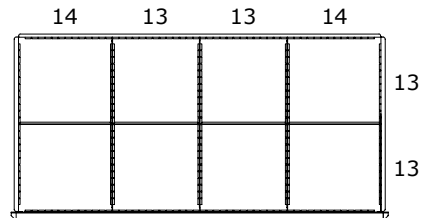

8 Compartments

D1-4824030-1313	3"
D1-4824045-1313	4-1/2"
D1-4824060-1313	6"
D1-4824075-1313	7-1/2"
D1-4824090-1313	9"
D1-4824105-1313	10-1/2"
D1-4824120-1313	12"

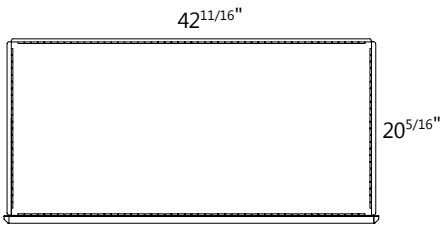

1 Compartment

D1-4824030-0000	3"
D1-4824045-0000	4-1/2"
D1-4824060-0000	6"
D1-4824075-0000	7-1/2"
D1-4824090-0000	9"
D1-4824105-0000	10-1/2"
D1-4824120-0000	12"



ROLL-OUT SHELVES

- Easy access to large, bulky items.
- Supports even loads of 400 lbs.
- Drawer front is notched to allow flush access to top of reinforcing channels.

PART#	W x D
D1-3618R	36" x 18"
D1-3624R	36" x 24"
D1-4818R	48" x 18"
D1-4824R	48" x 24"

DRAWER MOUNTING BRACKET PANEL

- Works with Angle or Beaded Post.
- Part numbers consist of both uprights, making a set; one left and one right - includes mounting hardware.



Please specify color.

24"D PART#	18"D PART#	HEIGHT
D1-0624DMU	D1-0618DMU	6" High
D1-1224DMU	D1-1218DMU	12" High
D1-1824DMU	D1-1818DMU	18" High
D1-2424DMU	D1-2418DMU	24" High
D1-3624DMU	D1-3618DMU	36" High
D1-4824DMU	D1-4818DMU	48" High

• Part numbers include: drawer(s), slides, partitions and dividers (partitions & dividers - factory installed).

DRAWER INTERIOR COMPONENTS



DRAWER PARTITIONS (FRONT TO BACK)

Divides the drawer along its depth, adjustable every 20mm (0.799") center to center. Fabricated in galvanized steel (G60 finish) and two (2) self-tapping screws for attachment (screw part# MDC-0705).

Drawer Height					
Drawer Depth Clear (nominal)	Part Number for 3" Drawers (1-15/16"H)	Part Number for 4 1/2" Drawers (2-15/16"H)	Part Number for 6" & 7 1/2" Drawers (4-15/16"H)	Part Number for 9" Drawers (6-11/16"H)	Part Number for 10 1/2" & 12" Drawers (8-15/16"H)
13-15/16" (18D)	M1-02H-18P	M1-03H-18P	M1-05H-18P	M1-07H-18P	M1-09H-18P
20-5/16" (24D)	M1-02H-26P	M1-03H-26P	M1-05H-26P	M1-07H-26P	M1-09H-26P



DRAWER DIVIDERS (SIDE TO SIDE)

Divides the drawer along its width, adjustable every 20mm (0.799") center to center. Fabricated in galvanized steel (G60 finish) 16S* - 24S* lengths require two (2) self-tapping screws for attachment (screw part# MDC-0705).

Drawer Height					
Compartment Size - Clear Width (nominal)	Part # for 3" Drawers (1-15/16"H)	Part # for 4 1/2" Drawers (2-15/16"H)	Part # for 6" & 7 1/2" Drawers (4-15/16"H)	Part # for 9" Drawers (6-11/16"H)	Part # for 10 1/2" & 12" Drawers (8-15/16"H)
1-7/8" (3S)	M1-02H-03D	M1-03H-03D	M1-05H-03D	M1-07H-03D	M1-09H-03D
2-11/16" (4S)	M1-02H-04D	M1-03H-04D	M1-05H-04D	M1-07H-04D	M1-09H-04D
3-1/2" (5S)	M1-02H-05D	M1-03H-05D	M1-05H-05D	M1-07H-05D	M1-09H-05D
4-1/4" (6S)	M1-02H-06D	M1-03H-06D	M1-05H-06D	M1-07H-06D	M1-09H-06D
5-1/16" (7S)	M1-02H-07D	M1-03H-07D	M1-05H-07D	M1-07H-07D	M1-09H-07D
5-7/8" (8S)	M1-02H-08D	M1-03H-08D	M1-05H-08D	M1-07H-08D	M1-09H-08D
6-11/16" (9S)	M1-02H-09D	M1-03H-09D	M1-05H-09D	M1-07H-09D	M1-09H-09D
7-1/2" (10S)	M1-02H-10D	M1-03H-10D	M1-05H-10D	M1-07H-10D	M1-09H-10D
8-1/4" (11S)	M1-02H-11D	M1-03H-11D	M1-05H-11D	M1-07H-11D	M1-09H-11D
9-1/16" (12S)	M1-02H-12D	M1-03H-12D	M1-05H-12D	M1-07H-12D	M1-09H-12D
9-7/8" (13S)	M1-02H-13D	M1-03H-13D	M1-05H-13D	M1-07H-13D	M1-09H-13D
10-11/16" (14S)	M1-02H-14D	M1-03H-14D	M1-05H-14D	M1-07H-14D	M1-09H-14D
12-1/4" (16S)*	M1-02H-16D	M1-03H-16D	M1-05H-16D	M1-07H-16D	M1-09H-16D
13-1/8" (17S)*	M1-02H-17D	M1-03H-17D	M1-05H-17D	M1-07H-17D	M1-09H-17D
13-7/8" (18S)*	M1-02H-18D	M1-03H-18D	M1-05H-18D	M1-07H-18D	M1-09H-18D
17-7/8" (23S)*	M1-02H-23D	M1-03H-23D	M1-05H-23D	M1-07H-23D	M1-09H-23D
18-5/8" (24S)*	M1-02H-24D	M1-03H-24D	M1-05H-24D	M1-07H-24D	M1-09H-24D

RIVET-SPAN®

BOLTLESS SHELVING

Storage Solutions in a Snap.

Rivet-Span's easy assembly and variety of components make it the best choice for those looking for economical storage solutions. The system sets up with just a rubber mallet—no nuts, bolts or clips are required on standard units. Rivet-Span's universal (no left or right) beams, posts, and T-posts tie shelving units together to make it even more convenient to use. The ridged beams come in heights up to 96" and make it a great solution for retail back room storage, or commercial and industrial applications. Rivet-Span's ability to store a broad range of loads and sizes makes it perfect for storing difficult or oddly shaped items often found in automotive applications. Use Rivet-Span to create anything from counter units, tire racks, packing tables, garment/hang rod units, bulk storage, molding or long parts storage. Since no cross-braces are required, storage can be accessed from all sides, making this hand-loading only storage system even more efficient. Take down and reassembly is just as easy as the original set up. Rivet-Span decking is available in particle board or sprinkler-friendly wire mesh to meet your exact needs.

Rivet-Span's wide selection of posts and beams are designed to support all your storage demands.



Rivet Span unit with 24" deep beams and particle board decking. Used for archival storage of financial records.



Scan this QR Code to download **Rivet-Span** installation instructions

RIVET-SPAN®



(01)



(02)



(03)



(04)



(05)



(06)



(07)

BEAM EXAMPLES

**DOUBLE RIVET
LOW PROFILE
BEAM**

**DOUBLE
RIVET
Z BEAM**

PARTICLE BOARD DECKING



WATERFALL WIRE DECKING

*Corners
Notched
to fit inside
posts.*



FLAT WIRE DECKING

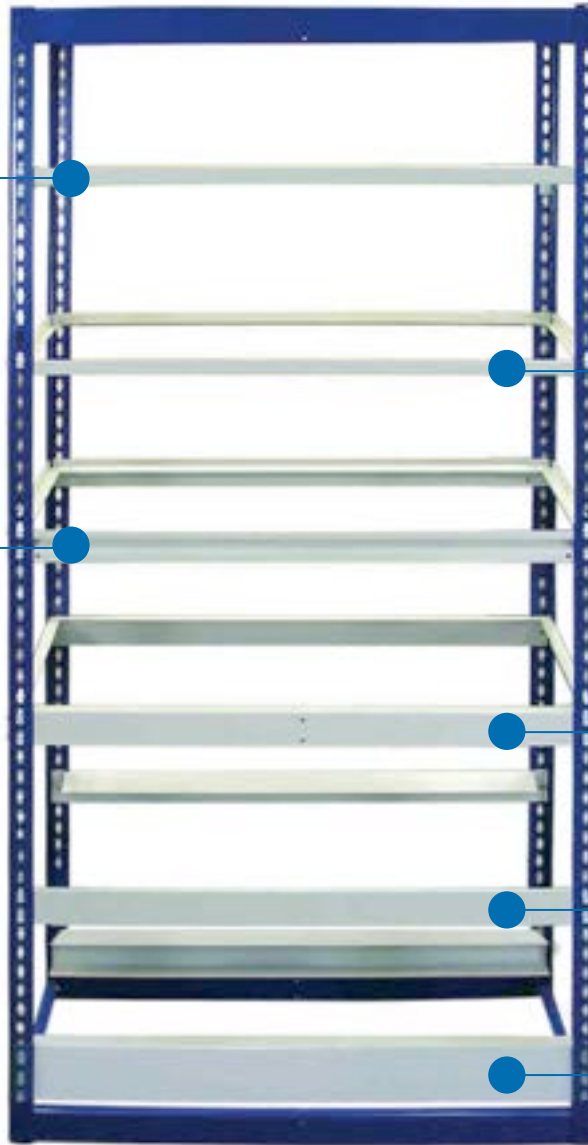

**SINGLE
RIVET BEAM**

**DOUBLE RIVET
ANGLE BEAM**

TIRE BEAM

**DOUBLE RIVET
CHANNEL BEAM**

BEAM PROFILES



TIRE BEAM
Tires and wheels -
Standard duty



**DOUBLE RIVET Z
BEAM 69" & 72"**
Standard duty bulk storage



**DOUBLE RIVET
CHANNEL BEAM**
Heavy duty bulk storage



**DOUBLE RIVET LOW
PROFILE BEAM**
Heavy duty shelving



**DOUBLE RIVET
ANGLE BEAM**
Standard duty bulk storage



**SINGLE RIVET
BEAM**
Standard duty shelving



**DOUBLE RIVET Z
BEAM 12" TO 60"**
Heavy duty shelving

BEAM SPECIFICATIONS

BEAM CAPACITIES

Beam Length	Single Rivet Beam	Double Rivet Low Profile Beam	Double Rivet Z Beam	Double Rivet Z Beam w/o Tie	Double Rivet Angle Beam	Double Rivet Angle Beam w/Support Tie	Double Rivet Channel Beam w/Support Tie
36"	350	450	1,400	—	1,400	—	—
42"	260	430	1,350	—	1,000	—	—
48"	240	400	1,300	1,600	730	1,700	—
60"	—	—	800	950	680	1,300	2,250
69"	—	—	600	900	460	1,100	1,900
72"	—	—	600	900	450	1,050	1,700
96"	—	—	—	—	240	650	1,300

- (1) support tie per level except 96" which has (2) support ties.
- The longest pair of beams at a given level determines the capacity for the entire level.
- Capacities are for steel beams only and do not reflect the capacity of the decking material.

POST CAPACITIES

Calculated Post Capacities Pounds Allowable Load Per Post		
Maximum Beam Spacing	Angle Post	Heavy-Duty Angle Post
48"	1,170	1,750
42"	1,315	1,960
36"	1,460	2,180
30"	1,605	2,390
24"	1,750	2,610
18"	1,896	2,830
12"	2,040	3,050

- Maximum beam spacing is determined as the distance between left-to-right beams or front-to-back beams, whichever is greater.
- Capacities are for vertical loads only where seismic forces are not a factor.

1.57" x 1.57"



ANGLE POST

1.875" x 1.875"



HD ANGLE POST





SHELF UNITS

Rivet-Span can also be used as quick, low-cost steel wood shelving. Single rivet and double rivet low profile beams provide maximum space between shelf levels. Plus, Rivet-Span is ideal for double entry shelving units. It can be accessed from all four sides because no cross braces or face braces are required for stability.

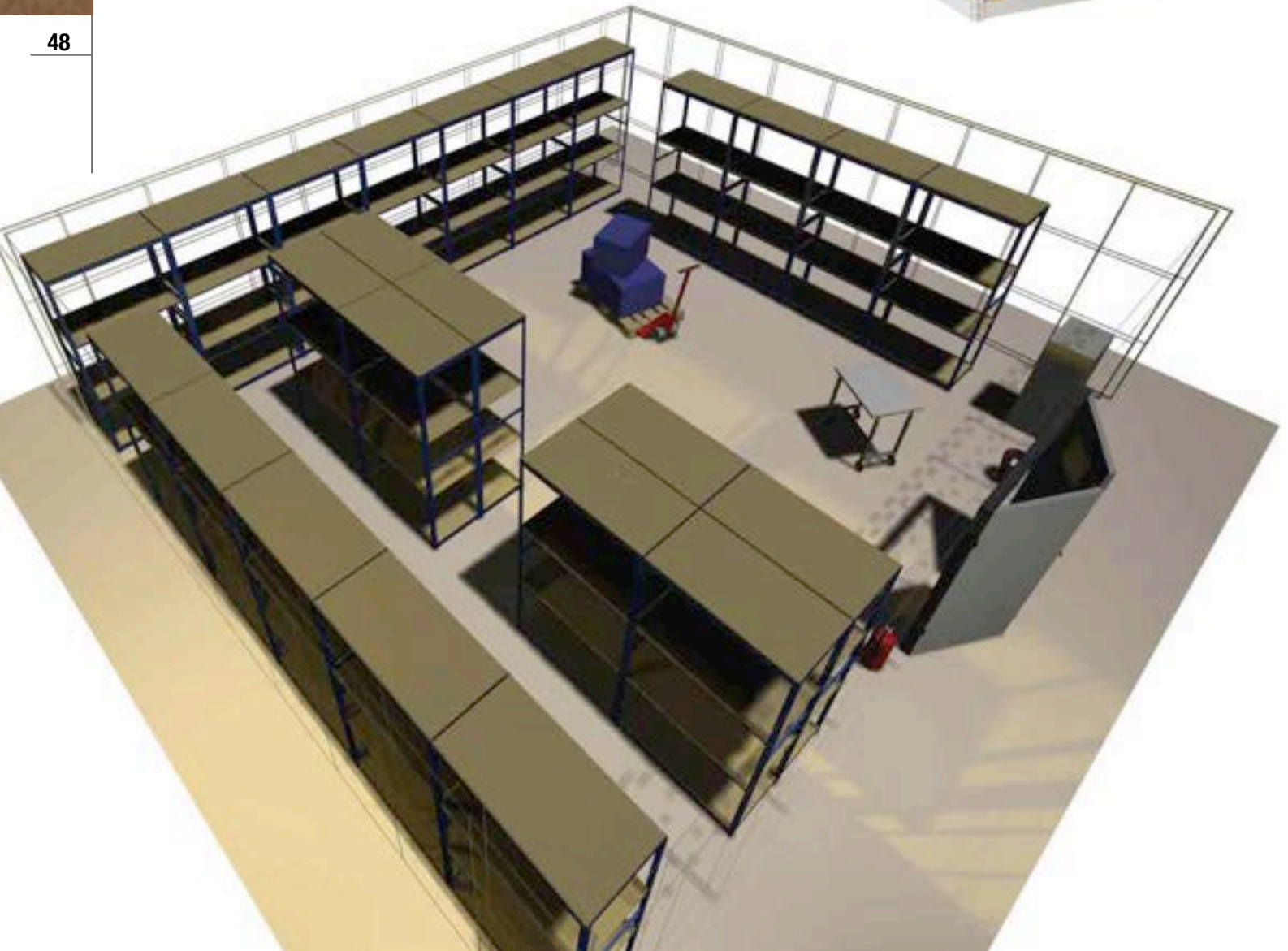

- Designed for units up to 48" wide.
- Uses single rivet or double rivet low profile beams on intermediate levels.
- Uses full "perimeter" double rivet angle beams at the top and bottom levels for rigidity.
- Shelf levels adjust on 1^{1/2}" centers.
- T Posts provide additional savings on runs of shelving.

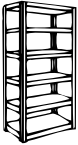

PRE-CONFIGURED SINGLE RIVET SHELF UNITS

		7'0" HIGH 6 BEAM LEVELS				
		Starter Unit PART #	Adder Unit	Depth	Capacity per Beam Level	Extra Shelf Level PART #
 36" Wide	36" Wide Units					
	B3612SR67	A3612SR67	12"	350 lbs	BL3612SR	
	B3618SR67	A3618SR67	18"	350 lbs.	BL3618SR	
	B3624SR67	A3624SR67	24"	350 lbs.	BL3624SR	
	B3636SR67	A3636SR67	36"	350 lbs.	BL3636SR	
42" Wide Units						
 42" Wide	B4212SR67	A4212SR67	12"	260 lbs.	BL4212SR	
	B4218SR67	A4218SR67	18"	260 lbs.	BL4218SR	
	B4224SR67	A4224SR67	24"	260 lbs.	BL4224SR	
	B4236SR67	A4236SR67	36"	260 lbs.	BL4236SR	
48" Wide Units						
 48" Wide	B4812SR67	A4812SR67	12"	240 lbs.	BL4812SR	
	B4818SR67	A4818SR67	18"	240 lbs.	BL4818SR	
	B4824SR67	A4824SR67	24"	240 lbs.	BL4824SR	
	B4836SR67	A4836SR67	36"	240 lbs.	BL4836SR	

PRE-CONFIGURED DOUBLE RIVET, LOW PROFILE SHELF UNITS

		7'0" HIGH 7 BEAM LEVELS				
		Starter Unit PART #	Adder Unit PART #	Depth	Capacity per Beam Level	Extra Shelf Level PART #
 36" Wide	36" Wide Units					
	B3612LP77	A3612LP77	12"	450 lbs.	BL3612LP	
	B3618LP77	A3618LP77	18"	450 lbs.	BL3618LP	
	B3624LP77	A3624LP77	24"	450 lbs.	BL3624LP	
	B3636LP77	A3636LP77	36"	450 lbs.	BL3636LP	
42" Wide Units						
 42" Wide	B4212LP77	A4212LP77	12"	430 lbs.	BL4212LP	
	B4218LP77	A4218LP77	18"	430 lbs.	BL4218LP	
	B4224LP77	A4224LP77	24"	430 lbs.	BL4224LP	
	B4236LP77	A4236LP77	36"	430 lbs.	BL4236LP	
48" Wide Units						
 48" Wide	B4812LP77	A4812LP77	12"	400 lbs.	BL4812LP	
	B4818LP77	A4818SR67	18"	400 lbs.	BL4818LP	
	B4824LP77	A4824LP77	24"	400 lbs.	BL4824LP	
	B4836LP77	A4836LP77	36"	400 lbs.	BL4836LP	
<ul style="list-style-type: none"> • Starter Unit has (4) angle posts; Adder Unit has (2) T posts. • All units include double rivet angle beams, left-to-right and front-to-back, at the top and bottom beam levels. • Capacities are for steel beams only with evenly distributed loads and do not reflect the capacity of the decking material. • All units include metal framing only. Decking material must be ordered separately. • Shelf units 24" deep or less include only (2) intermediate front-to-back single rivet beams. Units 30" or deeper include front-to-back single rivet beams at every intermediate beam level. • Extra shelf levels 24" deep or less include left-to-right beams only. Extra shelf levels 30" or deeper also include front-to-back single rivet beams. 						

BULK STORAGE UNITS

Simple, economical storage that is strong for today's wide variety of hand-loaded bulky, heavy, or hard-to-store items. Rivet-Span offers a complete range of sizes with spans and depths wider and greater than conventional shelving.

- Designed for spans of 48" to 96" wide.
- Choice of beam capacity to meet your storage requirements.
- Uses double rivet angle, channel or Z beams.
- Beam levels adjust on 1 1/2" centers.
- T-Post adder units further reduce material investment and installation time.



- Starter unit has (4) angle posts;
- Adder unit has (2) T posts.
- Capacities are for steel beams only with evenly distributed loads and do not reflect the capacity of the decking material.
- All units include metal frame only. Decking material must be ordered separately.
- Includes (1) support tie, except 96" which has (2) support ties.
- Units with channel beams have angle beams with support ties located directly at the floor level.



Have questions, or need help with your order? Our Customer Service Dept. is available Monday-Friday, 8am - 5pm (ET).

Call 1-800-748-0227 x 4801.

PRE-CONFIGURED BULK STORAGE UNITS

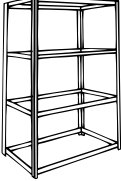
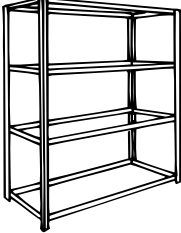
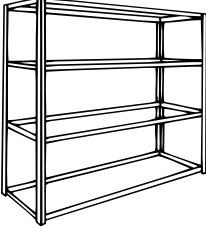
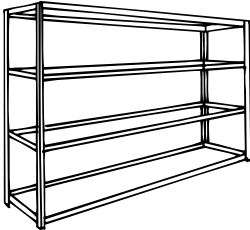
		7'0" HIGH 4 BEAM LEVELS					
		Starter Unit PART #	Adder Unit PART #	Unit Depth	Capacity Per Beam Level (lbs.)	Beam Type	Extra Beam Level PART #
48" Wide 	48" Wide Units						
	B4818DR47	A4818DR47	18"	730	Angle	BL4818DR	
	B4824DR47	A4824DR47	24"	730	Angle	BL4824DR	
	B4830DR47	A4830DR47	30"	730	Angle	BL4830DR	
	B4836DR47	A4836DR47	36"	730	Angle	BL4836DR	
	B4848DR47	A4848DR47	48"	730	Angle	BL4848DR	
60" Wide 	60" Wide Units						
	B6018DR47	A6018DR47	18"	680	Angle	BL6018DR	
	B6018DH47	A6018DH47	18"	1300	Angle	BL6018DH	
	B6018CH47	A6018CH47	18"	2250	Channel	BL6018CH	
	B6024DR47	A6024DR47	24"	680	Angle	BL6024DR	
	B6024DH47	A6024DH47	24"	1300	Angle	BL6024DH	
	B6024CH47	A6024CH47	24"	2250	Channel	BL6024CH	
	B6030DR47	A6030DR47	30"	680	Angle	BL6030DR	
	B6030DH47	A6030DH47	30"	1300	Angle	BL6030DH	
	B6030CH47	A6030CH47	30"	2250	Channel	BL6030CH	
	B6036DR47	A6036DR47	36"	680	Angle	BL6036DR	
	B6036DH47	A6036DH47	36"	1300	Angle	BL6036DH	
	B6036CH47	A6036CH47	36"	2250	Channel	BL6036CH	
	B6048DR47	A6048DR47	48"	680	Angle	BL6048DR	
B6048DH47	A6048DH47	48"	1300	Angle	BL6048DH		
B6048CH47	A6048CH47	48"	2250	Channel	BL6048CH		
72" Wide 	72" Wide Units						
	B7218DR47	A7218DR47	18"	450	Angle	BL7218DR	
	B7218DH47	A7218DH47	18"	1050	Angle	BL7218DH	
	B7218CH47	A7218CH47	18"	1700	Channel	BL7218CH	
	B7224DR47	A7224DR47	24"	450	Angle	BL7224DR	
	B7224DH47	A7224DH47	24"	1050	Angle	BL7224DH	
	B7224CH47	A7224CH47	24"	1700	Channel	BL7224CH	
	B7230DR47	A7230DR47	30"	450	Angle	BL7230DR	
	B7230DH47	A7230DH47	30"	1050	Angle	BL7230DH	
	B7230CH47	A7230CH47	30"	1700	Channel	BL7230CH	
	B7236DR47	A7236DR47	36"	450	Angle	BL7236DR	
	B7236DH47	A7236DH47	36"	1050	Angle	BL7236DH	
	B7236CH47	A7236CH47	36"	1700	Channel	BL7236CH	
	B7248DR47	A7248DR47	48"	450	Angle	BL7248DR	
B7248DH47	A7248DH47	48"	1050	Angle	BL7248DH		
B7248CH47	A7248CH47	48"	1700	Channel	BL7248CH		
96" Wide 	96" Wide Units						
	B9618DH47	A9618DH47	18"	650	Angle	BL9618DH	
	B9618CH47	A9618CH47	18"	1300	Channel	BL9618CH	
	B9624DH47	A9624DH47	24"	650	Angle	BL9624DH	
	B9624CH47	A9624CH47	24"	1300	Channel	BL9624CH	
	B9630DH47	A9630DH47	30"	650	Angle	BL9630DH	
	B9630CH47	A9630CH47	30"	1300	Channel	BL9630CH	
	B9636DH47	A9636DH47	36"	650	Angle	BL9636DH	
	B9636CH47	A9636CH47	36"	1300	Channel	BL9636CH	
	B9648DH47	A9648DH47	48"	650	Angle	BL9648DH	
B9648CH47	A9648CH47	48"	1300	Channel	BL9648CH		

PRE-CONFIGURED BULK STORAGE UNITS

BULK STORAGE TYPE FOR USE WITH DECKING							
Starter Unit PART #	Adder Unit PART #	Unit Width	Unit Depth	Unit Height	Beam Levels	Type of Box	Number of Boxes
For 1 Cubic Foot Boxes							
B6915DR36	A6915DR36	69"	15"	6'	3	1 cu. ft.	30
B6915DR47	A6915DR47	69"	15"	7'	4	1 cu. ft.	40
B6915DR59	A6915DR59	69"	15"	9'	5	1 cu. ft.	50
Boxes stored 5 across x 2 High x 1 Deep • All beam levels utilized for storage							
B6930DH36	A6930DH36	69"	30"	6'	3	1 cu. ft.	60
B6930DH47	A6930DH47	69"	30"	7'	4	1 cu. ft.	80
B6930DH59	A6930DH59	69"	30"	9'	5	1 cu. ft.	100
Boxes stored 5 across x 2 High x 2 Deep • All beam levels utilized for storage							
B6948CH36	A6948CH36	69"	48"	6'	3	1 cu. ft.	90
B6948CH47	A6948CH47	69"	48"	7'	4	1 cu. ft.	120
B6948CH59	A6948CH59	69"	48"	9'	5	1 cu. ft.	150
Boxes stored 5 across x 2 High x 3 Deep • All beam levels utilized for storage							
For 1.5 Cubic Foot Boxes							
B6924DR36	A6924DR36	69"	24"	6'	3	1.5 cu. ft.	30
B6924DR47	A6924DR47	69"	24"	7'	4	1.5 cu. ft.	40
B6924DR59	A6924DR59	69"	24"	9'	5	1.5 cu. ft.	50
Boxes stored 5 across x 2 High x 1 Deep • All beam levels utilized for storage							
B6948CH36	A6948CH36	69"	48"	6'	3	1.5 cu. ft.	60
B6948CH47	A6948CH47	69"	48"	7'	4	1.5 cu. ft.	80
B6948CH59	A6948CH59	69"	48"	9'	5	1.5 cu. ft.	100
Boxes stored 5 across x 2 High x 2 Deep • All beam levels utilized for							
BULK STORAGE TYPE FOR USE WITHOUT DECKING							
For 1 Cubic Foot Boxes							
B6915PR36	A6915PR36	69"	15"	6'	3	1 cu. ft.	30
B6915PR47	A6915PR47	69"	15"	7'	4	1 cu. ft.	40
Boxes stored 5 across x 2 High x 1 Deep • All beam levels utilized for storage							
B6930PH36	A6930PH36	69"	30"	6'	3	1 cu. ft.	60
B6930PH47	A6930PH47	69"	30"	7'	4	1 cu. ft.	80
<i>Boxes stored 5 across x 2 High x 2 Deep • All beam levels utilized for storage</i>							
SINGLE RIVET SHELF TYPE FOR USE WITH DECKING							
For 1 Cubic Foot Boxes							
B4215SR66	A4215SR66	42"	15"	6'	6	1 cu. ft.	18
B4215SR77	A4215SR77	42"	15"	7'	7	1 cu. ft.	21
B4215SR88	A4215SR88	42"	15"	8'	8	1 cu. ft.	24
Boxes stored 3 across x 1 High x 1 Deep • All beam levels utilized for storage							
B4224SR66	A4224SR66	42"	24"	6'	6	1.5 cu. ft.	18
B4224SR77	A4224SR77	42"	24"	7'	7	1.5 cu. ft.	21
B4224SR88	A4224SR88	42"	24"	8'	8	1.5 cu. ft.	24
Boxes stored 3 across x 1 High x 1 Deep • All beam levels utilized for storage							
NOTES:							
<ul style="list-style-type: none"> Record storage boxes not included. All units include metal framing only. Decking material must be ordered separately. 							

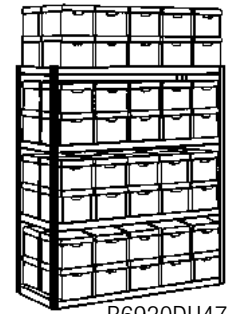

B6930DH47

Includes
Record Storage
Support Angles

No Decking Required

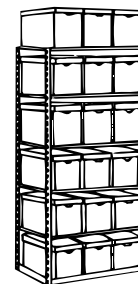





***Pictured here:** Scanlon Lexus, Ft. Myers, Florida – chose a waterfall decking option to accompany their Rivet-Span system. With its wide variety of configurations, Rivet-Span is able to accomodate a full range of sizes and shapes for items large to small, and the wire decking options keep your business up to local fire codes.*









*Scan this QR Code to
download **Rivet-Span**
installation instructions*

PRE-CONFIGURED UNITS

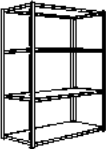
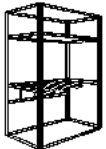
		RIVET-SPAN "Z BEAM" BULK STORAGE - 7' HIGH WITH 4 BEAM LEVELS				
		Starter Unit PART #	Adder Unit PART #	Unit Depth	Capacity Per Beam Level (lbs.)	Extra Beam Level
48" Wide		B4818ZB47	A4818ZB47	18"	1300	BL4818ZB
		B4824ZB47	A4824ZB47	24"	1300	BL4824ZB
		B4830ZB47	A4830ZB47	30"	1300	BL4830ZB
		B4836ZB47	A4836ZB47	36"	1300	BL4836ZB
		B4848ZB47	A4848ZB47	48"	1300	BL4848ZB
60" Wide		B6018ZB47	A6018ZB47	18"	800	BL6018ZB
		B6024ZB47	A6024ZB47	24"	800	BL6024ZB
		B6030ZB47	A6030ZB47	30"	800	BL6030ZB
		B6036ZB47	A6036ZB47	36"	800	BL6036ZB
		B6048ZB47	A6048ZB47	48"	800	BL6048ZB
72" Wide		B7218ZB47	A7218ZB47	18"	600	BL7218ZB
		B7224ZB47	A7224ZB47	24"	600	BL7224ZB
		B7230ZB47	A7230ZB47	30"	600	BL7230ZB
		B7236ZB47	A7236ZB47	36"	600	BL7236ZB
		B7248ZB47	A7248ZB47	48"	600	BL7248ZB

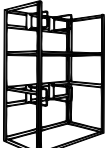
NOTES:

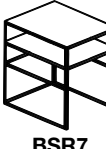
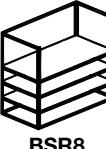
- Starter unit has four angle posts; Adder unit has two T posts.
- All units include metal frame only. Decking material must be ordered separately.
- Capacities are for steel beams only with evenly distributed loads and do not reflect the capacity of the decking material.

		AUTOMOTIVE STORAGE UNITS						
		Unit PART #	Unit Width	Unit Depth	Unit Height	Application		
	BSR1	BSR1-7236	72"	36"	8'	Bulky Parts		
		BSR1+7236	72"	36"	8'	Bulky Parts		
		BSR2-7236	72"	36"	8'	Bumpers & Bars		
	BSR2	BSR2+7236	72"	36"	8'	Bumpers & Bars		
		BSR3-7236	72"	36"	8'	Fenders & Doors		
		BSR3+7236	72"	36"	8'	Fenders & Doors		
	BSR3	BSR4-7236	72"	36"	8'	Two-Tier Fenders		
		BSR4+7236	72"	36"	8'	Two-Tier Fenders		
		BSR5-9636	96"	36"	8'	Hanging Parts		
	BSR4	BSR5+9636	96"	36"	8'	Hanging Parts		
		BSR6-4848	48"	48"	8'	Hoods		
		BSR6+4848	48"	48"	8'	Hoods		
	BSR5	BSR7-4860	48"	60"	8'	Deep Hoods		
		BSR7+4860	48"	60"	8'	Deep Hoods		
		BSR8-7236	72"	36"	8'	Top Tier Fenders		
	BSR6	BSR8+7236	72"	36"	8'	Top Tier Fenders		
		BSR9-9636	96"	36"	8'	Quarter Panels		
		BSR9+9636	96"	36"	8'	Quarter Panels		
	BSR7							
			BSR8					
					BSR9			

NOTES:

(-) means basic units - skeleton frame only; (+) means complete units - particle board decking, label holders and frame included.

PRE-CONFIGURED UNITS

TIRE RACKS			
Starter Unit PART #	Adder Unit	Unit Width	Unit Height
B60SETB37	A60SETB37	12"	7'
B60SETB40	A60SETB40	12"	10'
B60SETB52	A60SETB52	12"	12'
B60DETB37	A60DETB37	42"	7'
B60DETB40	A60DETB40	42"	10'
B60DETB52	A60DETB52	42"	12'

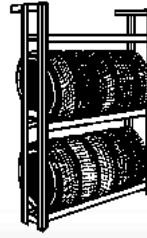

Single entry

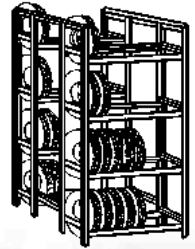

Double entry



POSTS & BEAMS

ANGLE POST

Standard upright post. 1.57" x 1.57", punched on 1 1/2" centers.

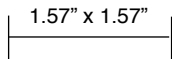

14 GAUGE STEEL

PART #	HEIGHT
10061-000	6'0"
10061-001	7'0"
10061-002	8'0"
10061-003	9'0"
10061-004	10'0"
10061-006	12'0"

T POST

Post between adjoining units to create starter and adder units. 3.34" x 1.57", punched on 1 1/2" centers.

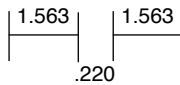

14 GAUGE STEEL

PART #	HEIGHT
10132-000	6'0"
10132-001	7'0"
10132-002	8'0"
10132-003	9'0"
10132-004	10'0"
10132-006	12'0"

HD ANGLE POST

Designed for maximum load capacity and stability. 1.875" x 1.875", punched on 1 1/2" centers.

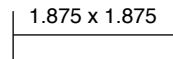

14 GAUGE STEEL

PART #	HEIGHT
10060-000	6'0"
10060-001	7'0"
10060-002	8'0"
10060-003	9'0"
10060-004	10'0"
10060-006	12'0"
10060-008	14'0"
10060-009	15'0"
10060-010	16'0"

SINGLE RIVET BEAM

Left-to-right and front-to-back support for shelf decking. 1" high.



PART #	WIDTH
10063-000	12"
10063-001	15"
10063-002	18"
10063-003	24"
10063-004	30"
10063-005	36"
10063-006	42"
10063-007	48"

DOUBLE RIVET CHANNEL BEAM

Higher capacity left-to-right support for bulk storage decking. 3" x 7/8", 14 gauge. Channel beams cannot be located directly at floor level due to their longer face. For a beam level directly at floor level, use double rivet angle beams with support ties.



PART #	WIDTH
10070-007	48"
10070-008	60"
10070-009	69"
10098-009*	69"
10070-010	72"
10070-013	84"
10070-011	96"

*Punched to accept Record Storage Support Angle.

DOUBLE RIVET LOW PROFILE BEAM

Heavier duty left-to-right support for shelf decking. 1 1/4" high.



PART #	WIDTH
16330-091	36"
16331-001	42"
16331-011	48"

TIRE BEAM

Left-to-right support for tires and wheels. 2 23/32" high.



PART #	WIDTH
10077-005	36"
10077-007	48"
10077-008	60"

BEAMS & ACCESSORIES

DOUBLE RIVET ANGLE BEAM

Standard left-to-right and front-to-back support for bulk storage decking and top and bottom level shelf decking. 2⁵/₈" x 7/8".



PART #	WIDTH
10068-000	12"
10068-001	15"
10068-002	18"
10068-003	24"
10068-004	30"
10068-012	32"
10068-005	36"
10068-006	42"
10068-007	48"
10068-008	60"
10068-009	69"
10097-009*	69"
10068-010	72"
10068-013	84"
10068-011	96"

*Punched to accept Record Storage Support Angle.

DOUBLE RIVET Z BEAM

Reduced profile left-to-right and front-to-back support recesses decking to provide additional vertical storage space and protect decking edges. 2¹/₄" high.



PART #	WIDTH
10142-000	12"
10142-001	15"
10142-002	18"
10142-003	24"
10142-004	30"
10142-012	32"
10142-005	36"
10142-006	42"
10142-007	48"
10142-008	60"
10144-009	69"
10144-010	72"

Z TIE

Used with Z Beam to support decking material.



PART #	WIDTH
10110-003	24"
10110-004	30"
10110-012	32"
10110-005	36"
10110-006	42"
10110-007	48"

T POST SPLICER

Extend the height of T Posts.



PART #
10145-000

ANGLE POST SPLICER

Used to extend the height of angle posts or heavy-duty angle posts.



PART #
10065-000

ANGLE POST TIE PLATE

Connects posts of adjacent angle post units to ensure structural stability and alignment.



PART #
10066-000

FOOT PLATE

Used for weight distribution and securing posts to the floor. Designed for single (row end) and double (intermediate) posts. Use with either standard or heavy-duty angle, or T posts. 4" x 2", 14 gauge.



PART #
10103-000

ACCESSORIES

RECORD STORAGE SUPPORT ANGLE



14 GAUGE STEEL

PART #	LENGTH
10099-000	15"
10099-001	30"

HANG ROD

Used for hanging items within a unit. One or more may be used per level. Accepts standard clothing hangers. Support at each end by either double rivet angle or channel beams. 1 1/4" x 1 1/4" (available in rounded or squared).

14 GAUGE STEEL



PART #	WIDTH
10104-012	36"
10104-013	48"
10104-014	60"

200 lb. capacity evenly displaced



PART #	WIDTH
10104-005	36"
10104-007	48"
10104-008	60"

175 lb. capacity evenly displaced

SLOTTED ANGLE CLEAT

Used where slotted angle pieces must be joined to Rivet-Span, such as top tie or special grating supports. Use one left and right, facing each other, when creating cross aisle supports.



14 GAUGE STEEL

PART #	Size
10113-000	Right
10113-001	Left

AISLE TIE

Top ties units together across aisles to maintain a constant aisle and stabilize units exceeding a height-to-depth ratio of 4. Not designed to support upper level walkways. 2 1/2" high.

14 GAUGE STEEL



PART #	Size
10073-000	30"
10073-001	36"
10073-002	42"
10073-003	48"

BACK SPACER TIE

Spaces back-to-back shelving units where space is required between units such as tire storage. 2 1/2" high.

14 GAUGE STEEL



PART #	Size
10079-000	18"

WALL TIE

Ties rack to wall for stability where space is required between unit and wall such as wheel storage. 2 1/2" high. Rivets only on one end.

14 GAUGE STEEL



PART #	Size
10075-000	9"

SUPPORT TIE

Adds support to decking material and increases capacity of double rivet angle and channel beams by limiting rotation. 2 1/2" high.

14 GAUGE STEEL



PART #	Size
10072-000	12"
10072-001	15"
10072-002	18"
10072-003	24"
10072-004	30"
10072-012	32"
10072-005	36"
10072-006	42"
10072-007	48"

ACCESSORIES & DECKING

AISLE/ FULL MAT DECKING SUPPORT

Supports steel decking in catwalk systems in aisle position. Turned over, supports decking for deck over or full mat multi-level systems. 3 1/2" high.



Scan this QR Code to download Rivet-Span installation instructions

PART #	WIDTH
10111-005	36"
10111-006	42"
10111-007	48"
10111-008	60"
10111-009	69"
10111-010	72"

PARTICLE BOARD DECKING

Particle board decking, 5/8" (.625) thick, is available pre-cut from Borroughs or it can be obtained direct from your local building supplier. Other types and thicknesses of decking material, such as plywood, structure wood, oriented strand board, and wire decking may be desired based upon load or use. These also can be obtained locally.

PART #	W x D	PART #	W x D	PART #	W x D
10095-000	36" x 12"	10095-012	48" x 18"	10095-024	69" x 30"
10095-001	36" x 15"	10095-013	48" x 24"	10095-025	72" x 18"
10095-002	36" x 18"	10095-014	48" x 30"	10095-026	72" x 24"
10095-003	36" x 24"	10095-015	48" x 36"	10095-027	72" x 30"
10095-004	36" x 30"	10095-016	48" x 38"	10095-028	72" x 36"
10095-005	42" x 12"	10095-017	60" x 18"	10095-029	72" x 48"
10095-006	42" x 15"	10095-018	60" x 24"	10095-030	96" x 18"
10095-007	42" x 18"	10095-019	60" x 30"	10095-031	96" x 24"
10095-008	42" x 24"	10095-020	60" x 36"	10095-032	96" x 30"
10095-009	42" x 30"	10095-021	60" x 48"	10095-033	96" x 36"
10095-010	48" x 12"	10095-022	69" x 15"	10095-034	96" x 48"
10095-011	48" x 15"	10095-023	69" x 24"		

WIRE DECKING – WATERFALL & FLAT

Borroughs has **flat** and **waterfall** wire decking options. Please contact your local Borroughs representative for quotes and specifications.

Pictured: Waterfall decking.

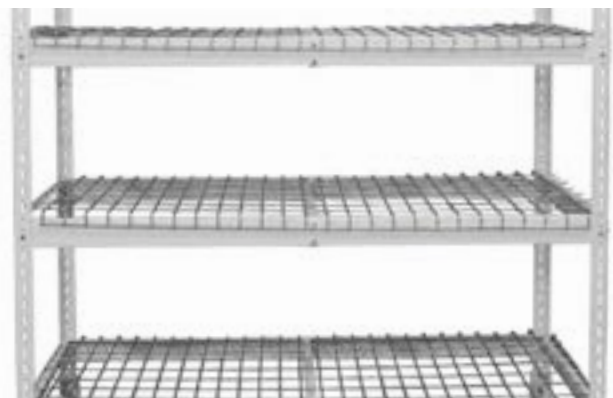

SPECIFICATION DATA

Rivet-Span® shelving units are made up of posts, side-to-side beams, and front-to-back beams. There are certain minimum requirements for beam use to ensure structural stability and safety. For example: all units must have a full "perimeter" of double rivet beams, meaning two side-to-side and two front-to-back, at both top and bottom of unit for stability. There are other requirements, see below.

Preconfigured Units - Include all required beams. Installation instructions (included with shipment) show how to position beams correctly.

Non-preconfigured Units - Follow these guidelines when specifying individual components:

- All units require a full perimeter of double rivet beams at top and bottom of unit.
- Single Rivet Beam (SRB) and Double Rivet Low Profile Beam (DRLPB) units 24" deep or less:
 - do not require SRB's front-to-back at each intermediate level in the unit.
 - 6'-8' high must have one SRB intermediate level front-to-back, located approximately in the middle of the unit.
 - 9'-10' high must have two SRB intermediate levels front-to-back, located to divide the height into 3 equal parts.
 - 11'-16' high must have three intermediate levels; a full perimeter of Double Rivet Beams (DRB) in the middle plus intermediate levels of front-to-back SRB's in the upper and lower halves of unit.

- Single Rivet Beam (SRB) and Double Rivet Low Profile Beam (DRLPB) units 30" deep or greater:

All units must have SRB's front-to-back at every intermediate level; units 11'-16' must have SRB's front-to-back at every intermediate level PLUS a full perimeter level of Double Rivet Beams (DRB) located approximately in the middle of the unit.

- Double Rivet Angle Beams (DRAB) and Double Rivet Channel Beams (DRCH) must have front-to-back beams at each beam level to provide decking support and ensure stability. When using DRCH from side-to-side, DRAB must be used from front-to-back.

- Tie Plates are recommended to tie adjacent Angle Post units together and to ensure structural stability. Tie plates should be used at the top and bottom of adjacent posts with additional tie plates spaced no more than 48" apart. Tie plates are not used on

Widths

Nominal unit width = 24", 30", 32", 36", 42", 48", 60", 69", 72", 84" or 96"
Actual single unit width = nominal width +1/2"

Depths

Nominal unit depth = 12", 15", 18", 24", 30", 32", 36", 42" or 48"
Actual single unit depth = nominal depth +1/2"
Actual back-to-back units depth = combined actual single unit depths +7/32"

Heights

Nominal unit height = 6', 7', 8', 10', 12', 14', 15' or 16'
Actual unit height = nominal height ±1/32"

Length of Run

Actual length of run = sum of actual unit widths +7/32" per adjoining unit

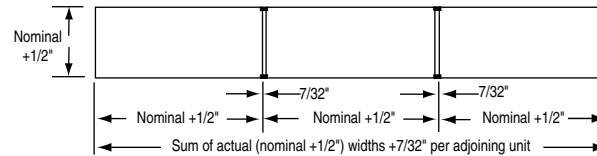

Horizontal Clear Openings

Actual clear opening between angle posts = nominal width - 2-5/8"
Actual clear opening between heavy-duty angle posts = nominal width - 3-1/4"

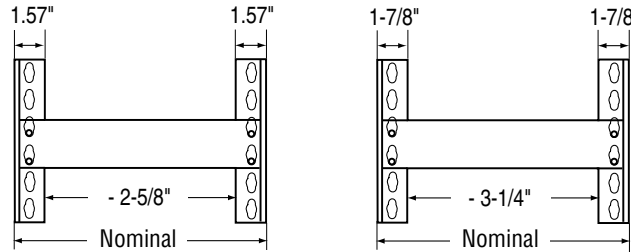

Vertical Adjustment and Clear Openings

All beams are adjustable on 1-1/2" centers

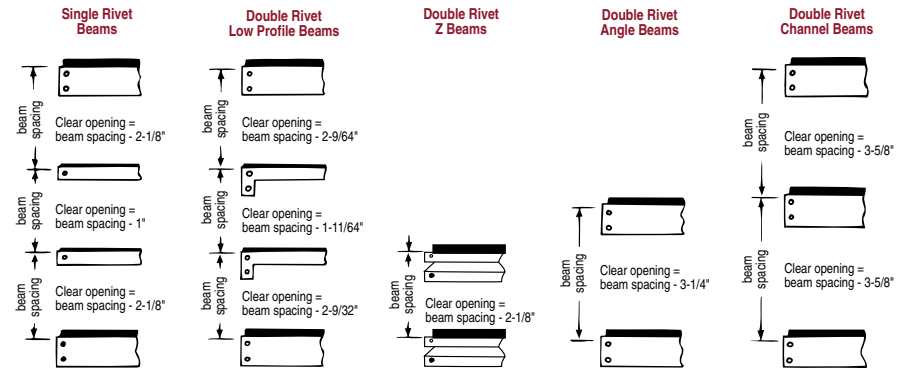

Vertical clearance calculated using 5/8" thick decking material

MODULAR DRAWER CABINETS



(01)



(02)



(03)



(04)



(05)



(06)



(07)

MODULAR DRAWER CABINETS

Designed for Efficiency. Built for Durability.

Our modular drawer cabinets combine the best features from the industry with cutting-edge design and manufacturing technologies to provide you the best Modular Drawer Cabinets on the market, at an affordable price. We've introduced a new drawer suspension system that attaches the drawer without hardware, has an auto safety clip to prevent accidental release, and has the smoothest progressive soft close available. The locking mechanism boasts a removal lock core for easy replacement if a key is lost or stolen. Enjoy a sleek design with drawer handles that are flush with the welded cabinet. Drawers extend 110% for retrieving items at the back of the drawers. Multiple widths, heights, and endless drawer configurations (factory installed partitions and dividers) make organizing your inventory and small to mid-size products/parts easy and efficient. The strength of our modular drawer cabinets allows them to be stacked up to five high. Protect your inventory while reducing your overall storage footprint.

Eye level modular drawer cabinets used for parts inventory at an outdoor equipment supplier in McKinney, Texas.



Scan this QR
Code to download
Modular Drawer
installation instructions

OPTION DETAILS – CABINET WIDTH & HEIGHT

4 PRE-CONFIGURED CABINET WIDTHS

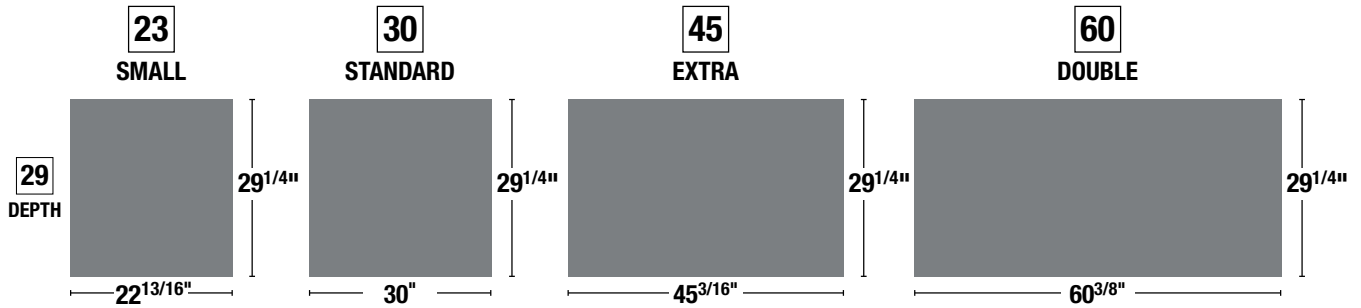

6 PRE-CONFIGURED CABINET HEIGHTS

Cabinets depicted here DO NOT INCLUDE base dimensions (fork truck, caster or stainless steel legs).

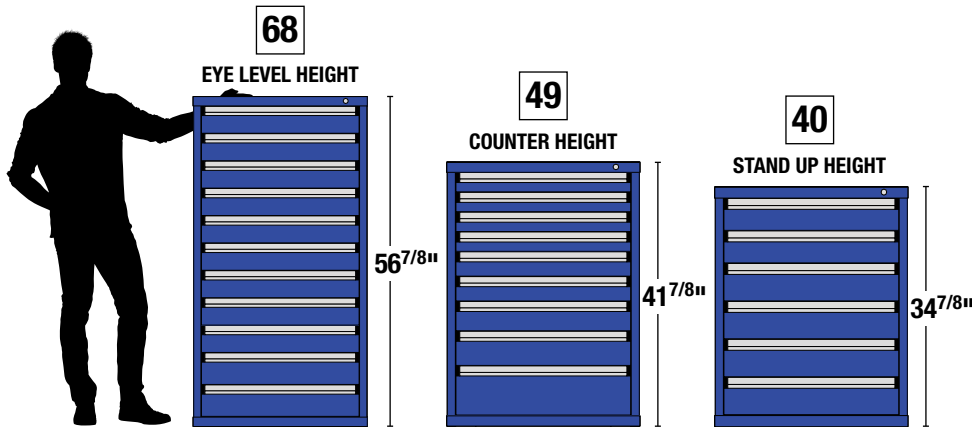

XX = NOMINAL SIZE, ALL DIMENSIONS ARE ACTUAL

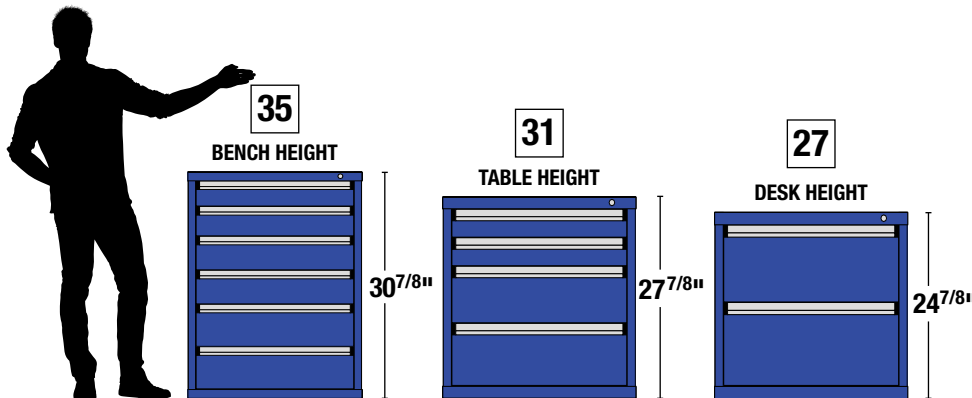

15 PRE-CONFIGURED DRAWER HEIGHTS

Drawer #	Usable Height
4	
5	2 1/4"
6	3 1/16"
7	3 7/8"
8	4 5/8"
9	5 7/16"
10	6 1/4"
11	7"
12	7 3/4"
13	8 9/16"
14	9 3/8"
15	10 1/8"
16	10 15/16"
17	11 3/4"
18	12 1/2"
19	13 5/16"

OPTION DETAILS – FEATURES & ACCESSORIES

SELECT INTERIORS



Drawer Interiors



Shelf Cabinet

Drawer Cabinets

- Pre-configured drawer cabinets come standard with pre-installed partitions and dividers.

Shelf Cabinets

- Shelf cabinets come standard with one adjustable shelf and a bottom shelf (49 & 68 height units come with an additional adjustable shelf).

SELECT SINGLE OR MULTI DRAWER ACCESS



- Pre-Configured cabinets come standard with multiple drawer access keyed

SELECT CABINET BASES



- **Fork truck bases** are 12 gauge providing ease of transport for cabinets while fully loaded.
- Fork truck base includes (2) covers.



- **Mobile bases** (pictured left) include - (2) rigid and (2) swivel casters with a brake.
- Mobile bases include push-pull handle.

* MOBILE BASES ONLY ON 40, 35, 31 AND 27 CABINET HEIGHTS.

SELECT DRAWER LOCK OPTIONS



Removable Cores



External Lock Bars



Cabinet Door Locks

Removable Lock Cores

- Allow for re-keying of cabinets if keys should be lost or stolen.
- Cores are available in different key codes or keyed alike, with a master key.

External Lock Bars

- Provides additional security, using pad locks at a single point to lock drawer access to entire cabinet.
- Keeps drawers secure if a no locking core system was previously purchased.

Door Lock Detail

- Door lock cylinder features 90-degree rotation and removable lock core.

Stainless Steel Kick-Plates

an add-on option for use with Stainless Steel Legs.



- **Stainless Steel Legs**



DRAWER CABINET PART NUMBER DEFINITION

Each number to the left of the cabinet represents the drawer number. A chart at the bottom of each page has been provided to give measurements of the **USABLE HEIGHT** as well as **DRAWER FRONT HEIGHT** for each drawer.

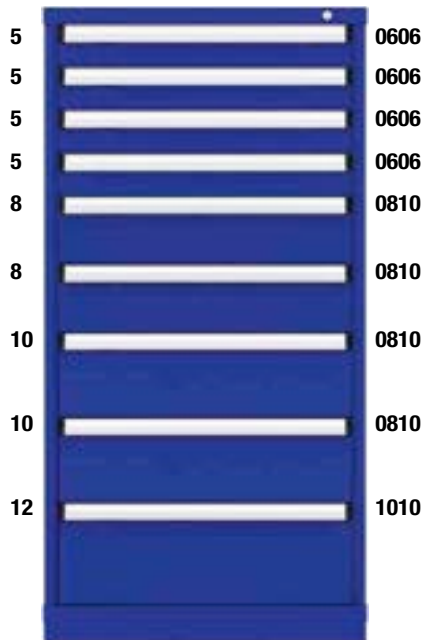

Each number to the right of the cabinet represents the drawer interior configuration - with factory installed partions and dividers.

- 23 drawer interiors are on page 69
- 30 drawer interiors are on page 76
- 45 drawer interiors are on page 81
- 60 drawer interiors are on page 85

MDC PRODUCT MODEL

M1 - 30 29 68 FT - MD 09 E L

CABINET WIDTH

OPTIONS = 23, 30, 45, 60

CABINET DEPTH

CABINET HEIGHT (in segments)

OPTIONS = 27, 31, 35, 40, 49, 68

DRAWER QUANTITY

CABINET BASE	
OPTION	DESCRIPTION
NB	NO BASE
FT	FORK TRUCK (adds 2-1/8" to height)
SL	STAINLESS LEG (adds 5-1/8" to height)
M5	*MOBILE BASE - 5" DIA (adds 7-1/2" to height)
M6	*MOBILE BASE - 6" DIA (adds 8-1/2" to height)

* ONLY AVAILABLE ON 40, 35, 31, 27 CABINET HEIGHTS

DRAWER LOCK	
OPTION	DESCRIPTION
NL	NO LOCK
MD	MULTIPLE DRAWER, KEYED DIFFERENT
MA	MULTIPLE DRAWER, KEYED ALIKE
SD	SINGLE DRAWER, KEYED DIFFERENT
SA	SINGLE DRAWER, KEYED ALIKE
SN	SINGLE DRAWER, NO LOCK

DRAWER CONFIGURATIONS

A PRE-DETERMINED LETTER THAT DEFINES A SPECIFIC GROUPING OF DRAWERS & INTERIORS

DRAWER INTERIORS	
OPTION	DESCRIPTION
E	EMPTY DRAWERS
L	PRE-CONFIGURED DRAWER INTERIORS (FACTORY INSTALLED)

- 02 02 (Add to end of product number above)

HOUSING COLOR

DRAWER COLOR

OPTION	DESCRIPTION
01	065 INDUSTRIAL GRAY
02	B504 BLUE
03	161 MIST GRAY
04	F604 PEBBLE
05	C386 RED
06	040 BLACK
07	445 WHITE

(See back page for details on color)

SHELF CABINET PART NUMBER DEFINITION



- All cabinets feature either one or two adjustable shelves.
- All cabinets feature a fixed lower shelf.

MDC PRODUCT MODEL

M1 - 30 29 35 NB - S 2 ND N F

CABINET WIDTH

OPTIONS = 23, 30, 45, 60

CABINET DEPTH

CABINET HEIGHT (in segments)

OPTIONS = 27, 31, 35, 40, 49, 68

SHELF QUANTITY

(2) = 27, 31, 35, 40, 49
(3) = 68

SHELF

DOOR TYPE

OPTION	DESCRIPTION
ND	NO DOOR
FH	FLUSH HINGED DOOR

DOOR LOCK TYPE

OPTION	DESCRIPTION
N	NO DOOR
D	KEY-DIFFERENT
A	KEY-ALIKE

CABINET BASE	
OPTION	DESCRIPTION
NB	NO BASE
FT	FORK TRUCK (adds 2-1/8" to height)
SL	STAINLESS LEG (adds 5-1/8" to height)
M5	*MOBILE BASE - 5" DIA (adds 7-1/2" to height)
M6	*MOBILE BASE - 6" DIA (adds 8-1/2" to height)

* ONLY AVAILABLE ON 40, 35, 31, 27 CABINET HEIGHTS

STACK CABINET

OPTION	DESCRIPTION
N	DO NOT STACK, SHIP SEPERATELY
F	*FACTORY STACK TO PREVIOUS CABINET LISTED ON ORDER

* TOTAL COMBINED HEIGHT MUST BE LESS THAN 90"

* STACKED CABINETS MUST BE THE SAME WIDTH AS THE CABINET BELOW.

- 02 02

HOUSING & SHELF COLOR
Overhead housing & shelf color are the same

OPTION	DESCRIPTION
01	065 INDUSTRIAL GRAY
02	B504 BLUE
03	161 MIST GRAY
04	F604 PEBBLE
05	C386 RED
06	040 BLACK
07	445 WHITE

(See back page for details on color)

23 SMALL WIDTH

ALL BORROUGHS PRE-CONFIGURED CABINETS FEATURE:

- 29 1/4" STANDARD DEPTH
- FORK TRUCK BASE WITH MULTIPLE DRAWER ACCESS & ARE KEYPED DIFFERENT
- PARTITIONS AND DIVIDERS FACTORY INSTALLED

STAND UP HEIGHT (22^{13/16"}W x 29^{1/4"}D x 37"H)

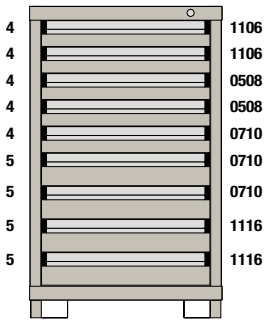

M1-232940FT-MD09AL
9 Drawers
91 Compartments

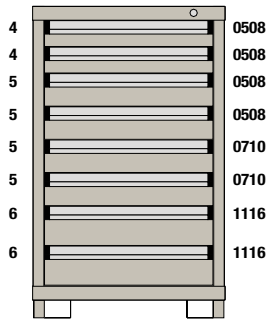

M1-232940FT-MD08AL
8 Drawers
90 Compartments

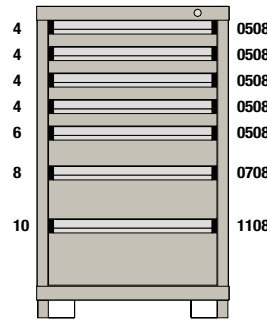

M1-232940FT-MD07AL
7 Drawers
100 Compartments

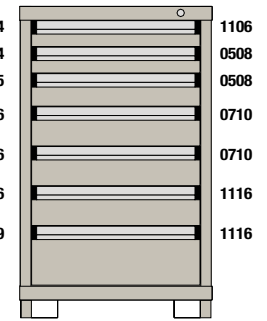

M1-232940FT-MD07BL
7 Drawers
86 Compartments

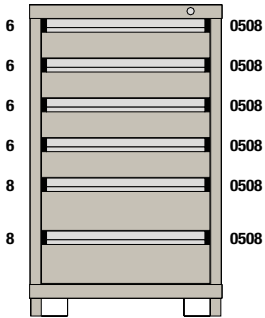

M1-232940FT-MD06BL
6 Drawers
96 Compartments

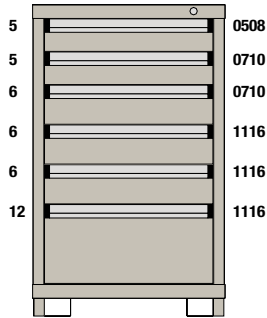

M1-232940FT-MD06CL
6 Drawers
46 Compartments

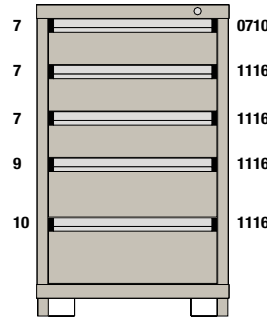

M1-232940FT-MD05AL
5 Drawers
25 Compartments

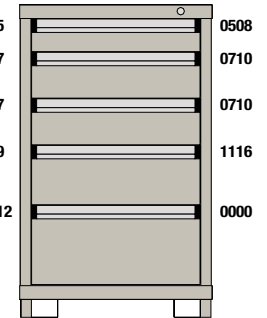

M1-232940FT-MD05BL
5 Drawers
39 Compartments



Need help choosing your cabinets?
Contact our Customer Service Team today. We will help you get the right cabinets for your needs.
1-800-748-0227 x4801

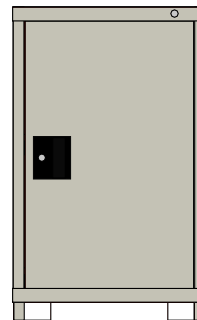

M1-232940FT-S2FHDN
Lockable swing door
Adjustable shelf
Lower fixed shelf

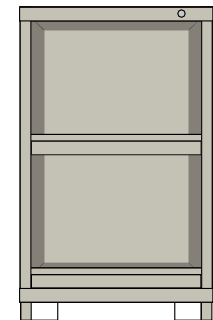

M1-232940FT-S2NDNN
Adjustable shelf
Lower fixed shelf

Drawer Table	Drawer Number	4	5	6	7	8	9	10	11	12	13	14	15	16	17	18
	Drawer Front	3 ^{1/16"}	3 ^{7/8"}	4 ^{5/8"}	5 ^{7/16"}	6 ^{3/16"}	7"	7 ^{3/4"}	8 ^{9/16"}	9 ^{3/8"}	10 ^{1/8"}	10 ^{15/16"}	11 ^{3/4"}	12 ^{1/2"}	13 ^{5/16"}	14 ^{1/16"}
	Usable Height	2 ^{1/4"}	3 ^{1/16"}	3 ^{7/8"}	4 ^{5/8"}	5 ^{7/16"}	6 ^{1/4"}	7"	7 ^{3/4"}	8 ^{9/16"}	9 ^{3/8"}	10 ^{1/8"}	10 ^{15/16"}	11 ^{3/4"}	12 ^{1/2"}	13 ^{5/16"}

23 SMALL WIDTH

ALL BORROUGHS PRE-CONFIGURED CABINETS FEATURE:

- 29 1/4" STANDARD DEPTH
- FORK TRUCK BASE WITH MULTIPLE DRAWER ACCESS & ARE KEYPED DIFFERENT
- PARTITIONS AND DIVIDERS FACTORY INSTALLED

BENCH HEIGHT (22^{13/16"}W x 29^{1/4"}D x 33"H)

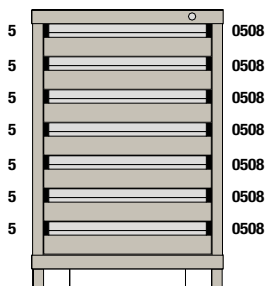

M1-232935FT-MD07AL
7 Drawers
112 Compartments

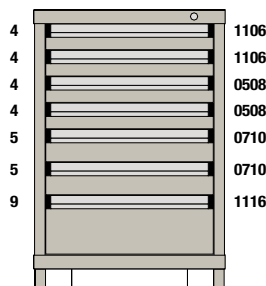

M1-232935FT-MD07BL
7 Drawers
74 Compartments

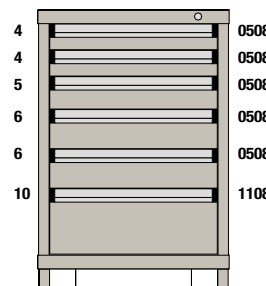

M1-232935FT-MD06AL
6 Drawers
88 Compartments

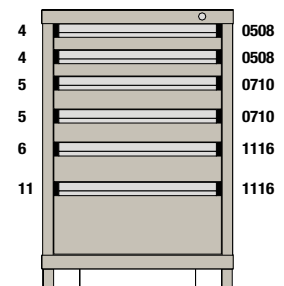

M1-232935FT-MD06CL
6 Drawers
58 Compartments

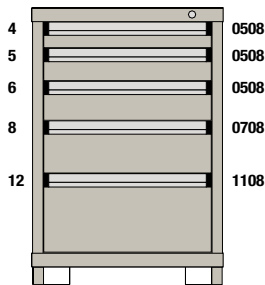

M1-232935FT-MD05AL
5 Drawers
68 Compartments

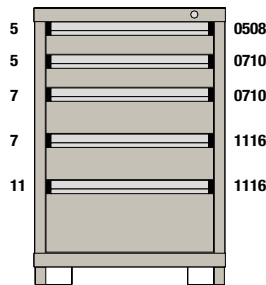

M1-232935FT-MD05BL
5 Drawers
42 Compartments

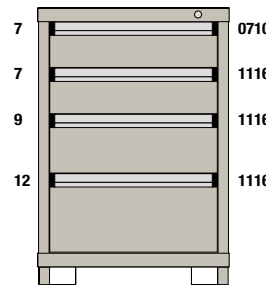

M1-232935FT-MD04AL
4 Drawers
21 Compartments

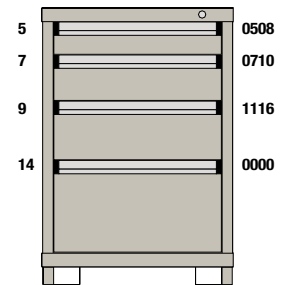

M1-232935FT-MD04BL
4 Drawers
30 Compartments



Pictured Here: The Magic Kingdom uses Borroughs Modular Drawer Cabinets with Upper Cabinets for their 5S initiatives.

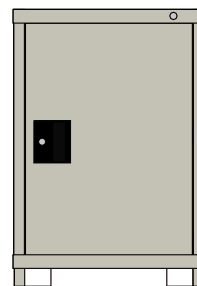

M1-232935FT-S2FHDN
Lockable swing door
Adjustable shelf
Lower fixed shelf

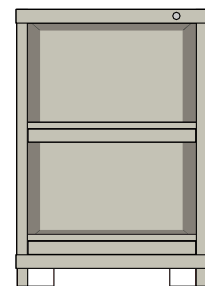

M1-232935FT-S2NDNN
Adjustable shelf
Lower fixed shelf

Drawer Table	Drawer Number	4	5	6	7	8	9	10	11	12	13	14	15	16	17	18
	Drawer Front	3 1/16"	3 7/8"	4 5/8"	5 7/16"	6 3/16"	7"	7 3/4"	8 9/16"	9 3/8"	10 1/8"	10 15/16"	11 3/4"	12 1/2"	13 5/16"	14 1/16"
	Usable Height	2 1/4"	3 1/16"	3 7/8"	4 5/8"	5 7/16"	6 1/4"	7"	7 3/4"	8 9/16"	9 3/8"	10 1/8"	10 15/16"	11 3/4"	12 1/2"	13 5/16"

23 SMALL WIDTH

ALL BORROUGHS PRE-CONFIGURED CABINETS FEATURE:

- 29 1/4" STANDARD DEPTH
- FORK TRUCK BASE WITH MULTIPLE DRAWER ACCESS & ARE KEYPED DIFFERENT
- PARTITIONS AND DIVIDERS FACTORY INSTALLED

TABLE HEIGHT (22^{13/16"} W x 29^{1/4"} D x 30" H)

<p>M1-232931FT-MD07BL 7 Drawers 77 Compartments</p>	<p>M1-232931FT-MD06AL 6 Drawers 132 Compartments</p>	<p>M1-232931FT-MD05AL 5 Drawers 112 Compartments</p>	<p>M1-232931FT-MD05BL 5 Drawers 49 Compartments</p>	<p>M1-232931FT-S2FH DN Lockable swing door Adjustable shelf Lower fixed shelf</p>
<p>M1-232931FT-MD05CL 5 Drawers 42 Compartments</p>	<p>M1-232931FT-MD04AL 4 Drawers 30 Compartments</p>	<p>M1-232931FT-MD04BL 4 Drawers 33 Compartments</p>	<p>M1-232931FT-MD03BL 3 Drawers 17 Compartments</p>	<p>M1-232931FT-S2ND NN Adjustable shelf Lower fixed shelf</p>

DESK HEIGHT (30" W x 29 1/4" D x 27" H)

<p>M1-232927FT-MD05AL 5 Drawers 144 Compartments</p>	<p>M1-232927FT-MD04AL 4 Drawers 41 Compartments</p>	<p>M1-232927FT-MD03AL 3 Drawers 50 Compartments</p>	<p>M1-232927FT-MD03CL 3 Drawers 44 Compartments</p>
<p>M1-232927FT-S2FH DN Lockable swing door Adjustable shelf Lower fixed shelf</p>	<p>M1-232927FT-S2ND NN Adjustable shelf Lower fixed shelf</p>		

Drawer Table	Drawer Number	4	5	6	7	8	9	10	11	12	13	14	15	16	17	18
	Drawer Front	3 ^{1/16"}	3 ^{7/8"}	4 ^{5/8"}	5 ^{7/16"}	6 ^{3/16"}	7"	7 ^{3/4"}	8 ^{9/16"}	9 ^{3/8"}	10 ^{1/8"}	10 ^{15/16"}	11 ^{3/4"}	12 ^{1/2"}	13 ^{5/16"}	14 ^{1/16"}
	Usable Height	2 ^{1/4"}	3 ^{1/16"}	3 ^{7/8"}	4 ^{5/8"}	5 ^{7/16"}	6 ^{1/4"}	7"	7 ^{3/4"}	8 ^{9/16"}	9 ^{3/8"}	10 ^{1/8"}	10 ^{15/16"}	11 ^{3/4"}	12 ^{1/2"}	13 ^{5/16"}

23 SMALL WIDTH DRAWER INTERIOR LAYOUT KITS

ALL BORROUGHS PRE-CONFIGURED CABINETS FEATURE:

- 29 1/4" STANDARD DEPTH
- FORK TRUCK BASE WITH MULTIPLE DRAWER ACCESS & ARE KEYPED DIFFERENT
- PARTITIONS AND DIVIDERS FACTORY INSTALLED

DRAWER INTERIOR CONFIGURATIONS (17 7/8"W x 25 1/8"D CLEAR)

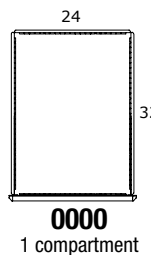
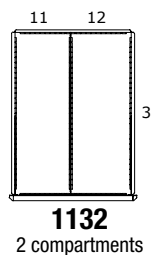
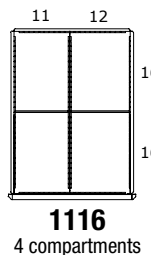
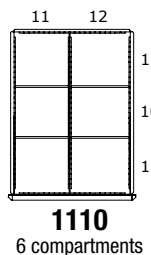
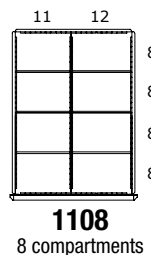
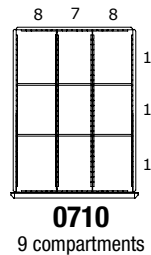
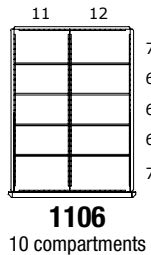
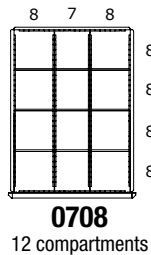
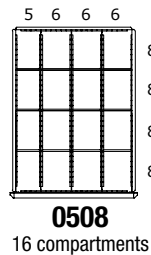
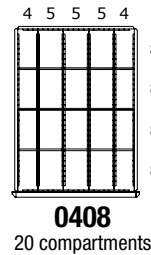
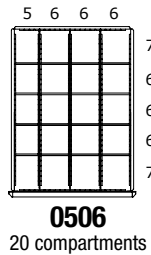
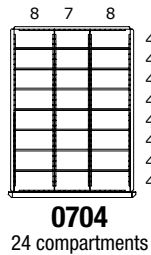
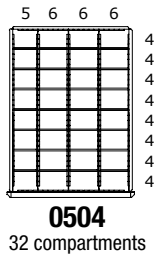

Numbers along the top and side of each drawer interior configuration refer to a specific compartment size. The corresponding dimensions are represented in the chart running along the bottom of the page.



Scan this QR Code to download **Modular Drawer** installation instructions

Compartment Size	3	4	5	6	7	8	9	10	11	12	13	14	15	16
Dimension (Clear)	1 7/8"	2 11/16"	3 1/2"	4 1/4"	5 1/16"	5 7/8"	6 11/16"	7 1/2"	8 1/4"	9 1/16"	9 7/8"	10 11/16"	11 1/2"	12 1/4"

30 STANDARD WIDTH

ALL BORROUGHS PRE-CONFIGURED CABINETS FEATURE:

- 29 1/4" STANDARD DEPTH
- FORK TRUCK BASE WITH MULTIPLE DRAWER ACCESS & ARE KEYPED DIFFERENT
- PARTITIONS AND DIVIDERS FACTORY INSTALLED

EYE LEVEL HEIGHT (30"W x 29 1/4"D x 59"H)

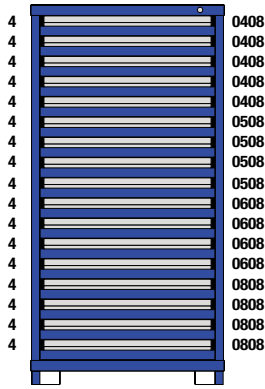

M1-302968FT-MD17AL
17 Drawers
400 Compartments

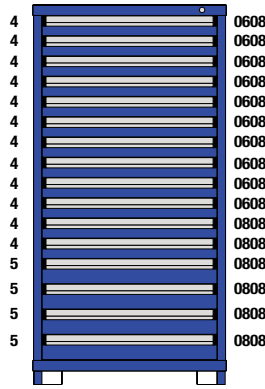

M1-302968FT-MD16AL
16 Drawers
296 Compartments

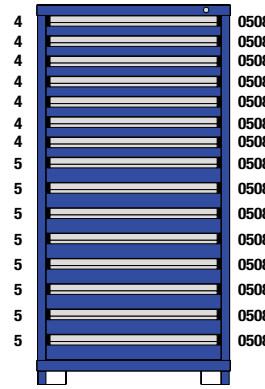

M1-302968FT-MD15AL
15 Drawers
360 Compartments

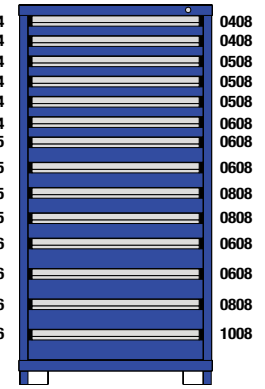

M1-302968FT-MD14AL
14 Drawers
300 Compartments

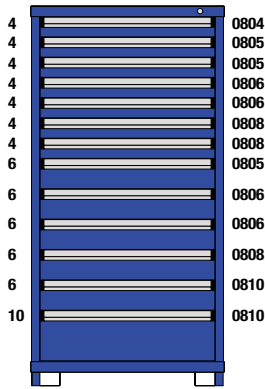

M1-302968FT-MD13AL
13 Drawers
256 Compartments

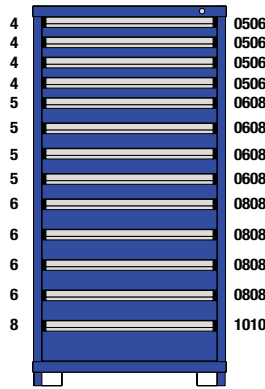

M1-302968FT-MD13BL
13 Drawers
273 Compartments

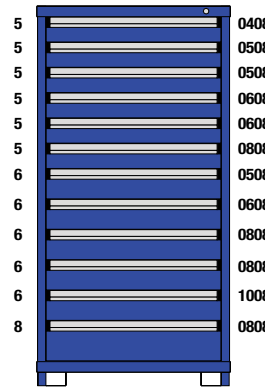

M1-302968FT-MD12CL
12 Drawers
240 Compartments

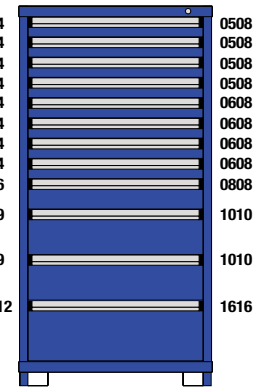

M1-302968FT-MD12EL
12 Drawers
214 Compartments

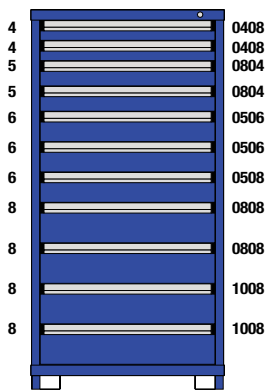

M1-302968FT-MD11AL
11 Drawers
268 Compartments

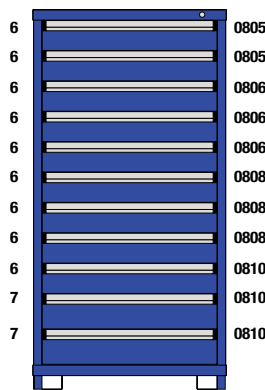

M1-302968FT-MD11CL
11 Drawers
192 Compartments

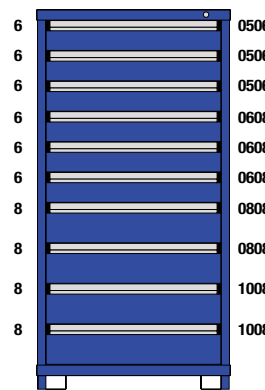

M1-302968FT-MD10AL
10 Drawers
206 Compartments

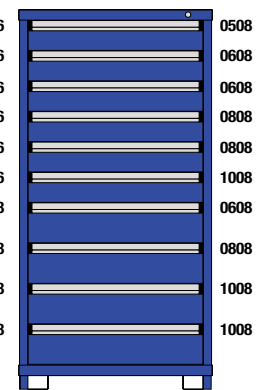

M1-302968FT-MD10DL
10 Drawers
168 Compartments

Drawer Number	4	5	6	7	8	9	10	11	12	13	14	15	16	17	18
Drawer Front	3 1/16"	3 7/8"	4 5/8"	5 7/16"	6 3/16"	7"	7 3/4"	8 9/16"	9 3/8"	10 1/8"	10 15/16"	11 3/4"	12 1/2"	13 5/16"	14 1/16"
Usable Height	2 1/4"	3 1/16"	3 7/8"	4 5/8"	5 7/16"	6 1/4"	7"	7 3/4"	8 9/16"	9 3/8"	10 1/8"	10 15/16"	11 3/4"	12 1/2"	13 5/16"

30 STANDARD WIDTH

ALL BORROUGHS PRE-CONFIGURED CABINETS FEATURE:

- 29 1/4" STANDARD DEPTH
- FORK TRUCK BASE WITH MULTIPLE DRAWER ACCESS & ARE KEYPED DIFFERENT
- PARTITIONS AND DIVIDERS FACTORY INSTALLED

EYE LEVEL HEIGHT (30"W x 29 1/4"D x 59"H)

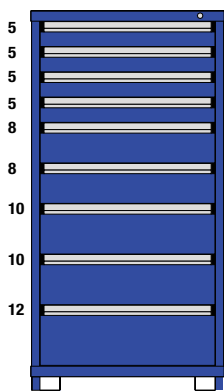

M1-302968FT-MD09AL
9 Drawers
157 Compartments

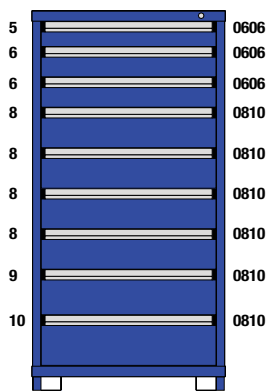

M1-302968FT-MD09CL
9 Drawers
147 Compartments

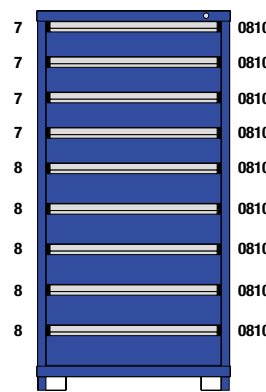

M1-302968FT-MD09HL
9 Drawers
108 Compartments

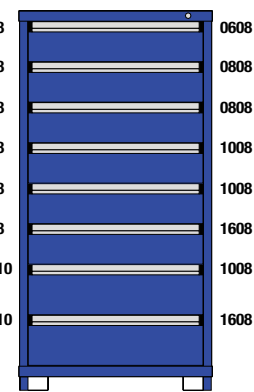

M1-302968FT-MD08CL
8 Drawers
104 Compartments

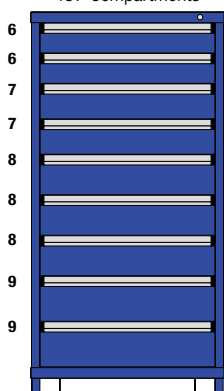

M1-302968FT-MD09DL
9 Drawers
144 Compartments

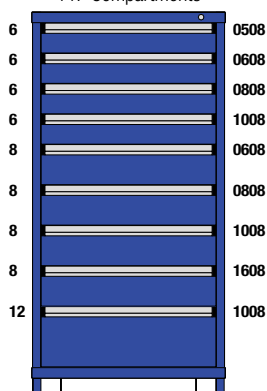

M1-302968FT-MD09EL
9 Drawers
140 Compartments

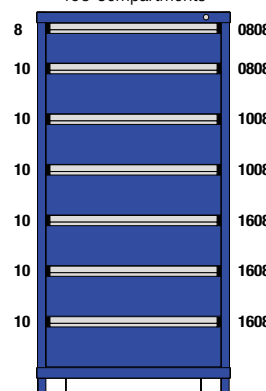

M1-302968FT-MD07AL
7 Drawers
128 Compartments

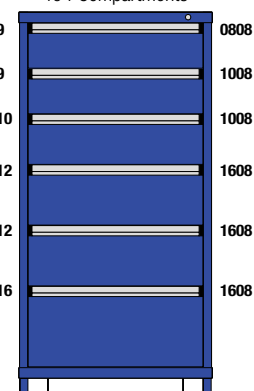

M1-302968FT-MD06AL
6 Drawers
64 Compartments

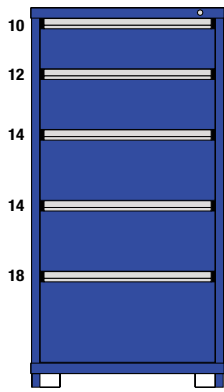

M1-302968FT-MD05AL
5 Drawers
37 Compartments

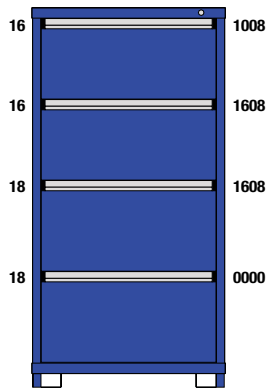

M1-302968FT-MD04AL
4 Drawers
29 Compartments

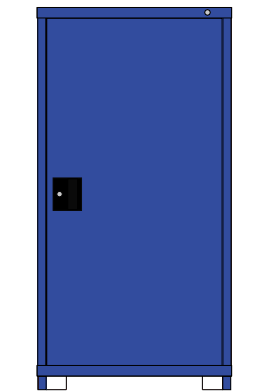

M1-302968FT-S3FHDN
Lockable swing door
Adjustable shelf (2)
Lower fixed shelf

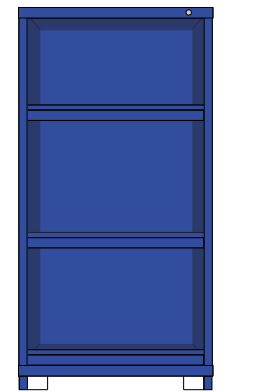

M1-302968FT-S3NDNN
Adjustable shelf (2)
Lower fixed shelf

Drawer Table	Drawer Number	4	5	6	7	8	9	10	11	12	13	14	15	16	17	18
	Drawer Front	3 1/16"	3 7/8"	4 5/8"	5 7/16"	6 3/16"	7"	7 3/4"	8 9/16"	9 3/8"	10 1/8"	10 15/16"	11 3/4"	12 1/2"	13 5/16"	14 1/16"
	Usable Height	2 1/4"	3 1/16"	3 7/8"	4 5/8"	5 7/16"	6 1/4"	7"	7 3/4"	8 9/16"	9 3/8"	10 1/8"	10 15/16"	11 3/4"	12 1/2"	13 5/16"

30 STANDARD WIDTH

ALL BORROUGHS PRE-CONFIGURED CABINETS FEATURE:

- 29 1/4" STANDARD DEPTH
- FORK TRUCK BASE WITH MULTIPLE DRAWER ACCESS & ARE KEYPED DIFFERENT
- PARTITIONS AND DIVIDERS FACTORY INSTALLED

COUNTER HEIGHT (30" W x 29 1/4" D x 44" H)

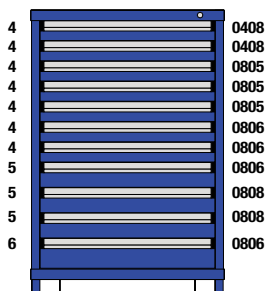

M1-302949FT-MD11AL
11 Drawers
248 Compartments

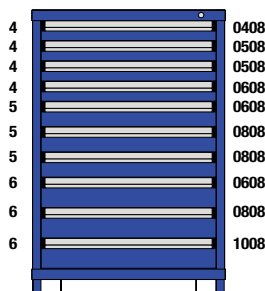

M1-302949FT-MD10BL
10 Drawers
200 Compartments

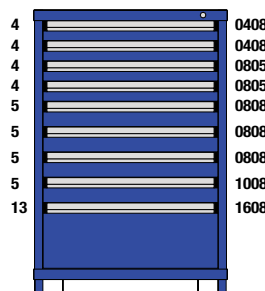

M1-302949FT-MD09CL
9 Drawers
180 Compartments

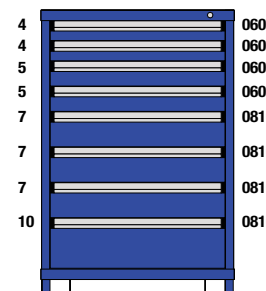

M1-302949FT-MD08CL
8 Drawers
148 Compartments

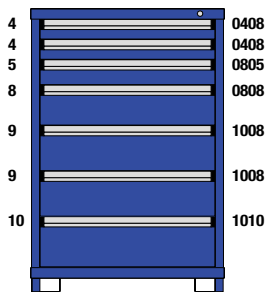

M1-302949FT-MD07AL
7 Drawers
137 Compartments

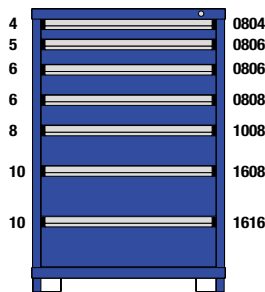

M1-302949FT-MD07CL
7 Drawers
112 Compartments

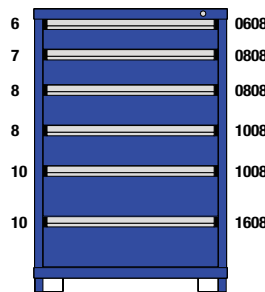

M1-302949FT-MD06BL
6 Drawers
84 Compartments

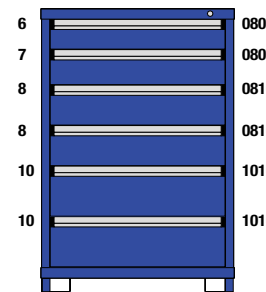

M1-302949FT-MD06CL
6 Drawers
74 Compartments

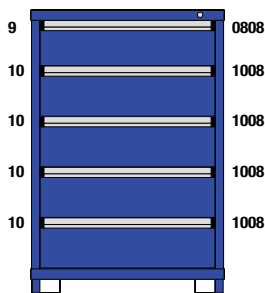

M1-302949FT-MD05AL
5 Drawers
64 Compartments

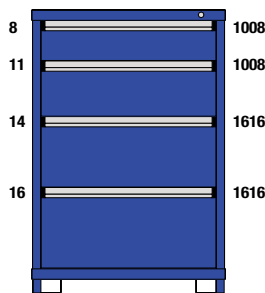

M1-302949FT-MD04AL
4 Drawers
29 Compartments

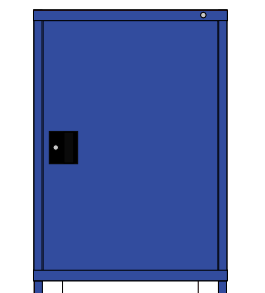

M1-302949FT-S3FHDN
Lockable swing door
Adjustable shelf
Lower fixed shelf

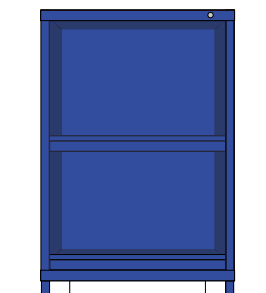

M1-302949FT-S3NDNN
Adjustable shelf
Lower fixed shelf

Drawer Number	4	5	6	7	8	9	10	11	12	13	14	15	16	17	18
Drawer Front	3 1/16"	3 7/8"	4 5/8"	5 7/16"	6 3/16"	7"	7 3/4"	8 9/16"	9 3/8"	10 1/8"	10 15/16"	11 3/4"	12 1/2"	13 5/16"	14 1/16"
Usable Height	2 1/4"	3 1/16"	3 7/8"	4 5/8"	5 7/16"	6 1/4"	7"	7 3/4"	8 9/16"	9 3/8"	10 1/8"	10 15/16"	11 3/4"	12 1/2"	13 5/16"

30 STANDARD WIDTH

ALL BORROUGHS PRE-CONFIGURED CABINETS FEATURE:

- 29 1/4" STANDARD DEPTH
- FORK TRUCK BASE WITH MULTIPLE DRAWER ACCESS & ARE KEYPED DIFFERENT
- PARTITIONS AND DIVIDERS FACTORY INSTALLED

STAND UP HEIGHT (30" W x 29 1/4" D x 37" H)

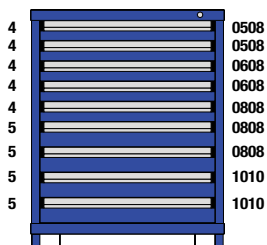

M1-302940FT-MD09DL
9 Drawers
154 Compartments

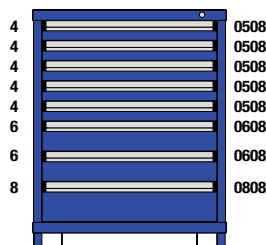

M1-302940FT-MD08DL
8 Drawers
176 Compartments

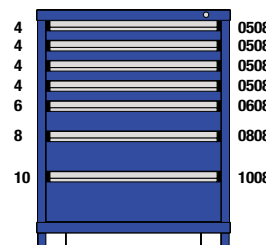

M1-302940FT-MD07AL
7 Drawers
144 Compartments

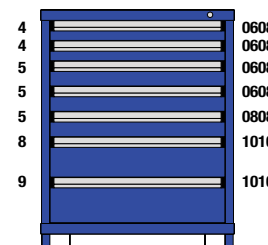

M1-302940FT-MD07DL
7 Drawers
114 Compartments

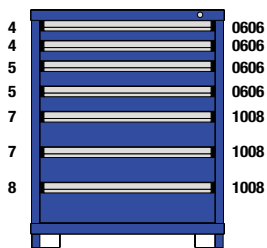

M1-302940FT-MD07FL
7 Drawers
136 Compartments

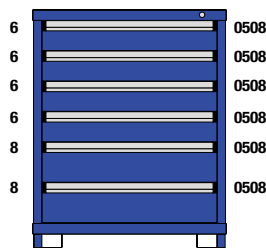

M1-302940FT-MD06AL
6 Drawers
144 Compartments

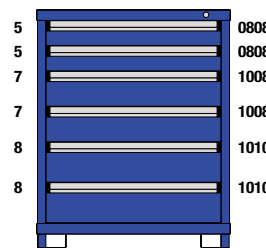

M1-302940FT-MD06DL
6 Drawers
74 Compartments

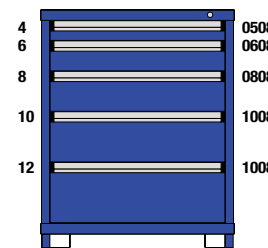

M1-302940FT-MD05DL
5 Drawers
84 Compartments

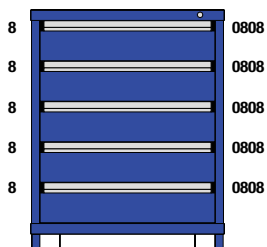

M1-302940FT-MD05FL
5 Drawers
80 Compartments

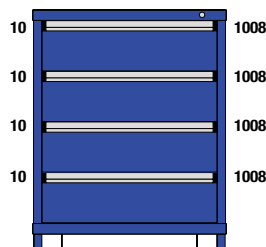

M1-302940FT-MD04DL
4 Drawers
29 Compartments

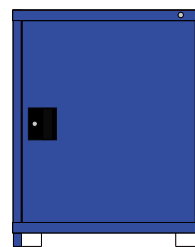

M1-302940FT-S2FHDN
Lockable swing door
Adjustable shelf
Lower fixed shelf

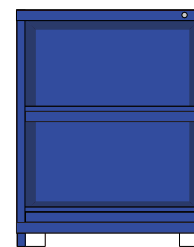

M1-302940FT-S2NDNN
Adjustable shelf
Lower fixed shelf

Drawer Number	4	5	6	7	8	9	10	11	12	13	14	15	16	17	18
Drawer Front	3 1/16"	3 7/8"	4 5/8"	5 7/16"	6 3/16"	7"	7 3/4"	8 9/16"	9 3/8"	10 1/8"	10 15/16"	11 3/4"	12 1/2"	13 5/16"	14 1/16"
Usable Height	2 1/4"	3 1/16"	3 7/8"	4 5/8"	5 7/16"	6 1/4"	7"	7 3/4"	8 9/16"	9 3/8"	10 1/8"	10 15/16"	11 3/4"	12 1/2"	13 5/16"

30 STANDARD WIDTH

ALL BORROUGHS PRE-CONFIGURED CABINETS FEATURE:

- 29 1/4" STANDARD DEPTH
- FORK TRUCK BASE WITH MULTIPLE DRAWER ACCESS & ARE KEYPED DIFFERENT
- PARTITIONS AND DIVIDERS FACTORY INSTALLED

BENCH HEIGHT (30"W x 29 1/4"D x 33"H)

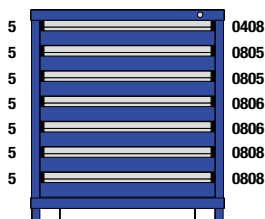

M1-302935FT-MD07AL
7 Drawers
152 Compartments

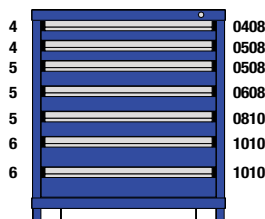

M1-302935FT-MD07BL
7 Drawers
133 Compartments

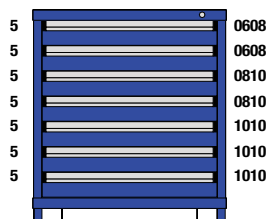

M1-302935FT-MD07CL
7 Drawers
91 Compartments

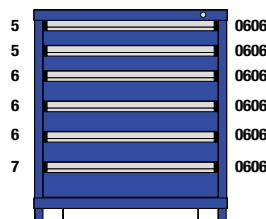

M1-302935FT-MD06AL
6 Drawers
150 Compartments

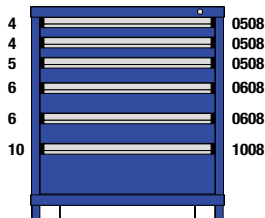

M1-302935FT-MD06BL
6 Drawers
124 Compartments

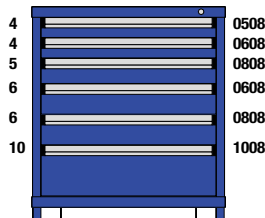

M1-302935FT-MD06CL
6 Drawers
108 Compartments

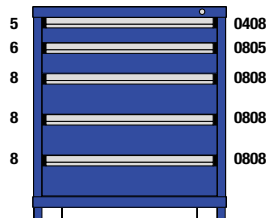

M1-302935FT-MD05AL
5 Drawers
104 Compartments

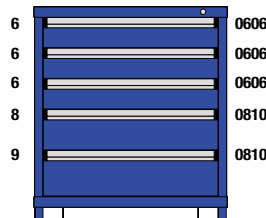

M1-302935FT-MD05BL
5 Drawers
99 Compartments

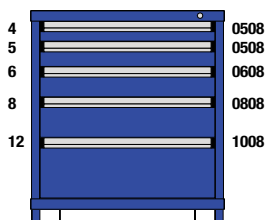

M1-302935FT-MD05CL
5 Drawers
96 Compartments

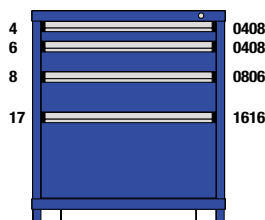

M1-302935FT-MD04AL
4 Drawers
88 Compartments

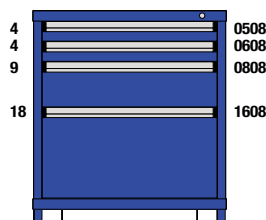

M1-302935FT-MD04BL
4 Drawers
68 Compartments

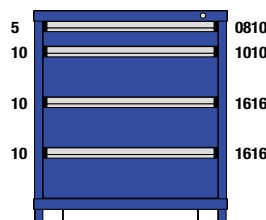

M1-302935FT-MD04DL
4 Drawers
29 Compartments

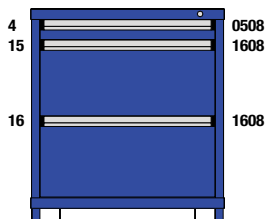

M1-302935FT-MD03AL
3 Drawers
40 Compartments

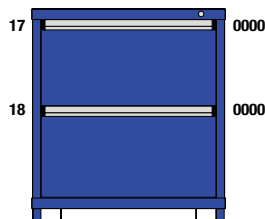

M1-302935FT-MD02AE
2 Drawers
21 Compartments

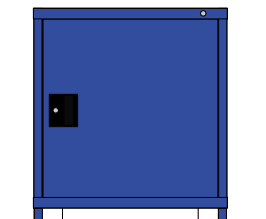

M1-302935FT-S2FHDN
Lockable swing door
Adjustable shelf
Lower fixed shelf

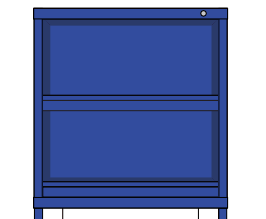

M1-302935FT-S2NDNN
Adjustable shelf
Lower fixed shelf

Drawer Number	4	5	6	7	8	9	10	11	12	13	14	15	16	17	18
Drawer Front	3 1/16"	3 7/8"	4 5/8"	5 7/16"	6 3/16"	7"	7 3/4"	8 9/16"	9 3/8"	10 1/8"	10 15/16"	11 3/4"	12 1/2"	13 5/16"	14 1/16"
Usable Height	2 1/4"	3 1/16"	3 7/8"	4 5/8"	5 7/16"	6 1/4"	7"	7 3/4"	8 9/16"	9 3/8"	10 1/8"	10 15/16"	11 3/4"	12 1/2"	13 5/16"

30 STANDARD WIDTH

ALL BORROUGHS PRE-CONFIGURED CABINETS FEATURE:

- 29 1/4" STANDARD DEPTH
- FORK TRUCK BASE WITH MULTIPLE DRAWER ACCESS & ARE KEYPED DIFFERENT
- PARTITIONS AND DIVIDERS FACTORY INSTALLED

TABLE HEIGHT (30"W x 29 1/4"D x 30"H)

M1-302931FT-MD06AL
6 Drawers
136 Compartments

M1-302931FT-MD06BL
6 Drawers
132 Compartments

M1-302931FT-MD05BL
5 Drawers
112 Compartments

M1-302931FT-MD05CL
5 Drawers
112 Compartments

M1-302931FT-MD04BL
4 Drawers
56 Compartments

M1-302931FT-MD03AL
3 Drawers
40 Compartments

M1-302931FT-S2FHDN
Lockable swing door
Adjustable shelf
Lower fixed shelf

M1-302931FT-S2NDNN
Adjustable shelf
Lower fixed shelf

DESK HEIGHT (30"W X 29 1/4"D X 27"H)

M1-302927FT-MD05AL
5 Drawers
112 Compartments

M1-302927FT-MD05BL
5 Drawers
144 Compartments

M1-302927FT-MD04AL
4 Drawers
41 Compartments

M1-302927FT-MD04BL
4 Drawers
80 Compartments

M1-302927FT-MD03BL
3 Drawers
48 Compartments

M1-302927FT-MD02AL
2 Drawers
16 Compartments

M1-302927FT-S2FHDN
Lockable swing door
Adjustable shelf
Lower fixed shelf

M1-302927FT-S2NDNN
Adjustable shelf
Lower fixed shelf

Drawer Table	Drawer Number	4	5	6	7	8	9	10	11	12	13	14	15	16	17	18
	Drawer Front	3 1/16"	3 7/8"	4 5/8"	5 7/16"	6 3/16"	7"	7 3/4"	8 9/16"	9 3/8"	10 1/8"	10 15/16"	11 3/4"	12 1/2"	13 5/16"	14 1/16"
	Usable Height	2 1/4"	3 1/16"	3 7/8"	4 5/8"	5 7/16"	6 1/4"	7"	7 3/4"	8 9/16"	9 3/8"	10 1/8"	10 15/16"	11 3/4"	12 1/2"	13 5/16"

30" MODULAR DRAWER INTERIOR LAYOUTS

ALL BORROUGHS PRE-CONFIGURED CABINETS FEATURE:

- 29 1/4" STANDARD DEPTH
- FORK TRUCK BASE WITH MULTIPLE DRAWER ACCESS & ARE KEYPED DIFFERENT
- PARTITIONS AND DIVIDERS FACTORY INSTALLED

DRAWER INTERIOR CONFIGURATIONS (25 1/8"W x 25 1/8"D CLEAR)

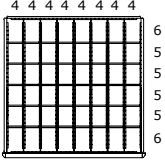
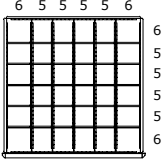
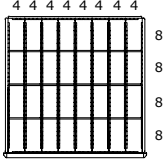
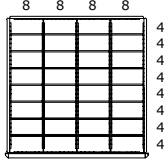
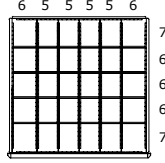
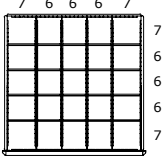
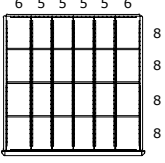
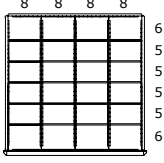
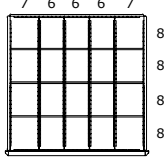
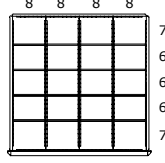
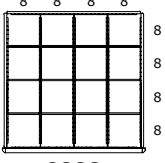
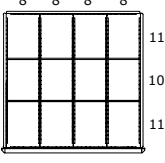
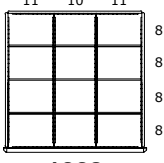
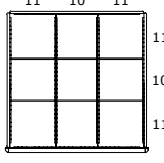
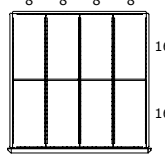
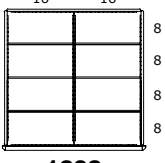
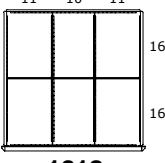
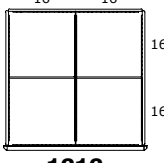
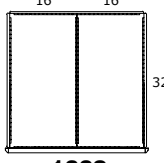
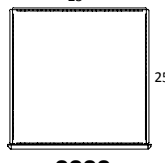
 <p>0405 48 compartments</p>	 <p>0505 36 compartments</p>	 <p>0408 32 compartments</p>	 <p>0804 32 compartments</p>	 <p>0506 30 compartments</p>
 <p>0606 25 compartments</p>	 <p>0508 24 compartments</p>	 <p>0805 24 compartments</p>	 <p>0608 20 compartments</p>	 <p>0806 20 compartments</p>
 <p>0808 16 compartments</p>	 <p>0810 12 compartments</p>	 <p>1008 12 compartments</p>	 <p>1010 9 compartments</p>	 <p>0816 8 compartments</p>
 <p>1608 8 compartments</p>	 <p>1016 6 compartments</p>	 <p>1616 4 compartments</p>	 <p>1632 2 compartments</p>	 <p>0000 1 compartment</p>

Numbers along the top and side of each drawer interior configuration refer to a specific compartment size. The corresponding dimensions are represented in the chart running along the bottom of the page.



Scan this QR Code to download **Modular Drawer** installation instructions

Compartment Size	3	4	5	6	7	8	9	10	11	12	13	14	15	16
Dimension (Clear)	1 7/8"	2 11/16"	3 1/2"	4 1/4"	5 1/16"	5 7/8"	6 11/16"	7 1/2"	8 1/4"	9 1/16"	9 7/8"	10 11/16"	11 1/2"	12 1/4"

45 EXTRA WIDTH

ALL BORROUGHS PRE-CONFIGURED CABINETS FEATURE:

- 29 1/4" STANDARD DEPTH
- FORK TRUCK BASE WITH MULTIPLE DRAWER ACCESS & ARE KEYPED DIFFERENT
- PARTITIONS AND DIVIDERS FACTORY INSTALLED

EYE LEVEL (45^{3/16}"W x 29^{1/4}"D x 59"H)

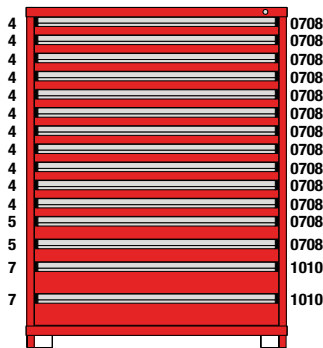

M1-452968FT-MD15AL
15 Drawers
446 Compartments

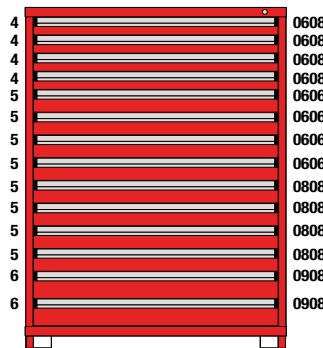

M1-452968FT-MD14AL
14 Drawers
484 Compartments

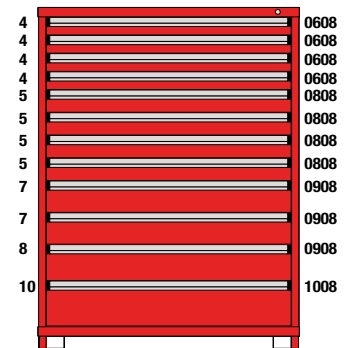

M1-452968FT-MD12AL
12 Drawers
348 Compartments

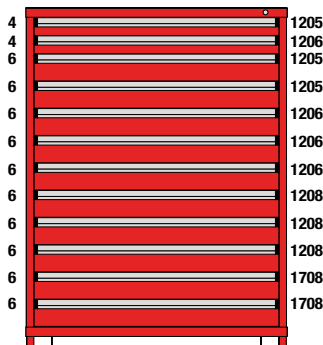

M1-452968FT-MD12BL
12 Drawers
224 Compartments

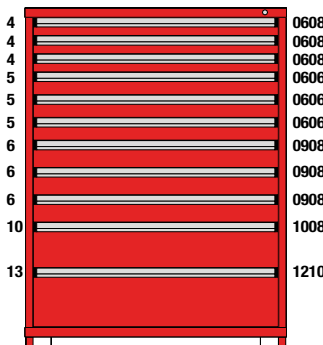

M1-452968FT-MD11AL
11 Drawers
317 Compartments

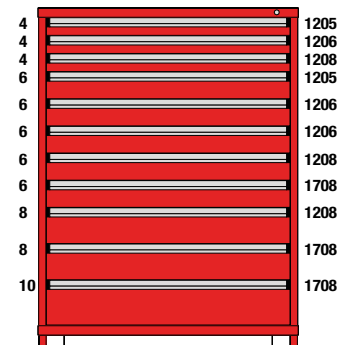

M1-452968FT-MD11BL
11 Drawers
192 Compartments

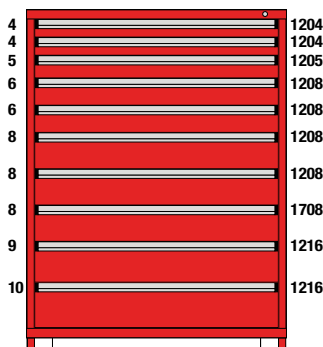

M1-452968FT-MD10AL
10 Drawers
180 Compartments

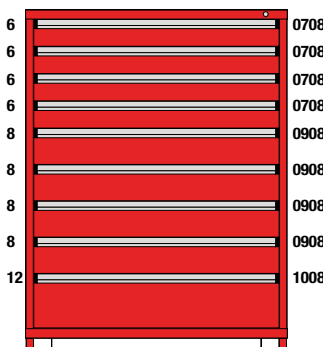

M1-452968FT-MD09AL
9 Drawers
244 Compartments

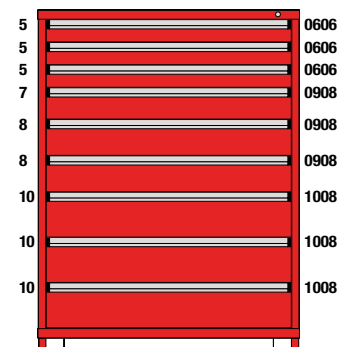

M1-452968FT-MD09BL
9 Drawers
237 Compartments

Drawer Table	Drawer Number	4	5	6	7	8	9	10	11	12	13	14	15	16	17	18
	Drawer Front	3 ^{1/16} "	3 ^{7/8} "	4 ^{5/8} "	5 ^{7/16} "	6 ^{3/16} "	7"	7 ^{3/4} "	8 ^{9/16} "	9 ^{3/8} "	10 ^{1/8} "	10 ^{15/16} "	11 ^{3/4} "	12 ^{1/2} "	13 ^{5/16} "	14 ^{1/16} "
	Usable Height	2 ^{1/4} "	3 ^{1/16} "	3 ^{7/8} "	4 ^{5/8} "	5 ^{7/16} "	6 ^{1/4} "	7"	7 ^{3/4} "	8 ^{9/16} "	9 ^{3/8} "	10 ^{1/8} "	10 ^{15/16} "	11 ^{3/4} "	12 ^{1/2} "	13 ^{5/16} "

45 EXTRA WIDTH

ALL BORROUGHS PRE-CONFIGURED CABINETS FEATURE:

- 29 1/4" STANDARD DEPTH
- FORK TRUCK BASE WITH MULTIPLE DRAWER ACCESS & ARE KEYPED DIFFERENT
- PARTITIONS AND DIVIDERS FACTORY INSTALLED

EYE LEVEL (45^{3/16}"W x 29^{1/4}"D x 59"H)

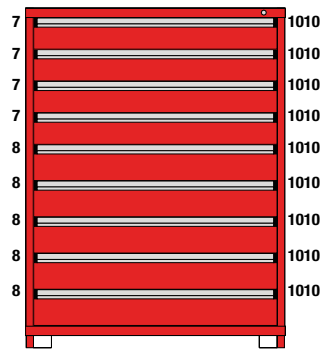

M1-452968FT-MD09CL
9 Drawers
135 Compartments

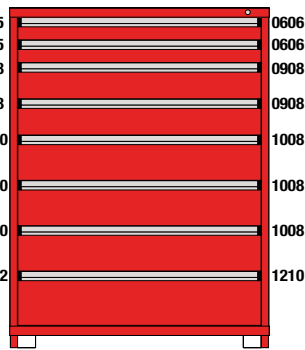

M1-452968FT-MD08AL
8 Drawers
190 Compartments

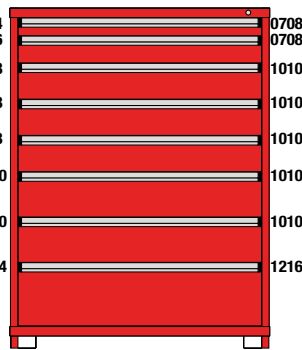

M1-452968FT-MD08BL
8 Drawers
147 Compartments

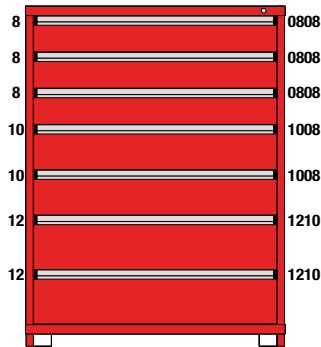

M1-452968FT-MD07AL
7 Drawers
148 Compartments

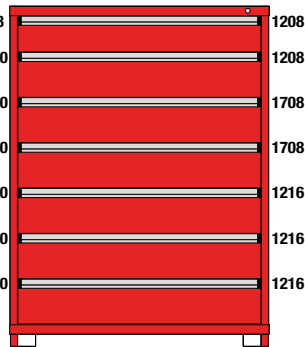

M1-452968FT-MD07BL
7 Drawers
80 Compartments

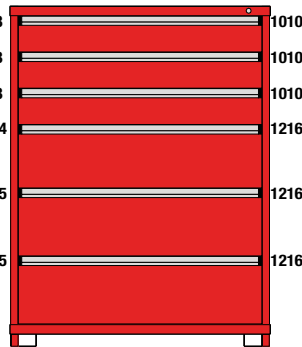

M1-452968FT-MD06AL
6 Drawers
69 Compartments

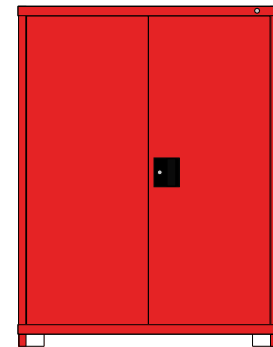

M1-452968FT-S3FHDN
Lockable swing door
Adjustable shelf (2)
Lower fixed shelf

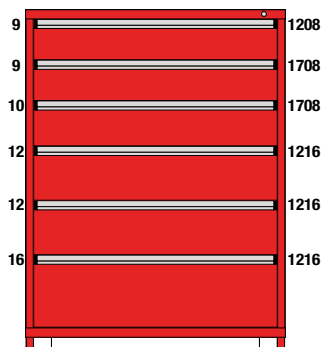

M1-452968FT-MD06BL
6 Drawers
64 Compartments

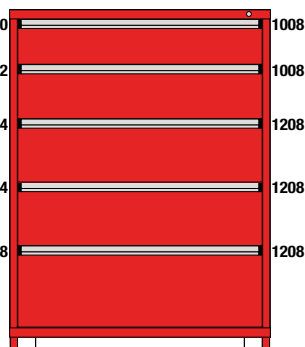

M1-452968FT-MD05AL
5 Drawers
88 Compartments

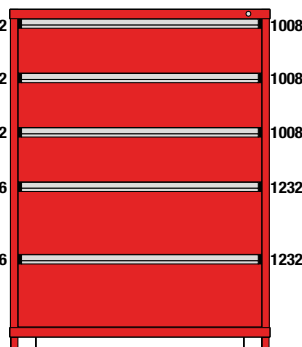

M1-452968FT-MD05BL
5 Drawers
66 Compartments

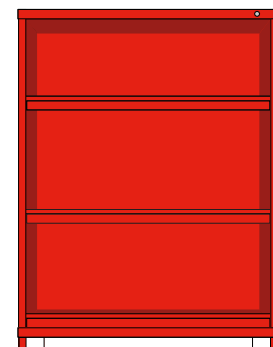

M1-452968FT-S3NDNN
Adjustable shelf (2)
Lower fixed shelf

Drawer Number	4	5	6	7	8	9	10	11	12	13	14	15	16	17	18
Drawer Front	3 ^{1/16} "	3 ^{7/8} "	4 ^{5/8} "	5 ^{7/16} "	6 ^{3/16} "	7"	7 ^{3/4} "	8 ^{9/16} "	9 ^{3/8} "	10 ^{1/8} "	10 ^{15/16} "	11 ^{3/4} "	12 ^{1/2} "	13 ^{5/16} "	14 ^{1/16} "
Usable Height	2 ^{1/4} "	3 ^{1/16} "	3 ^{7/8} "	4 ^{5/8} "	5 ^{7/16} "	6 ^{1/4} "	7"	7 ^{3/4} "	8 ^{9/16} "	9 ^{3/8} "	10 ^{1/8} "	10 ^{15/16} "	11 ^{3/4} "	12 ^{1/2} "	13 ^{5/16} "

45 EXTRA WIDTH

ALL BORROUGHS PRE-CONFIGURED CABINETS FEATURE:

- 29 1/4" STANDARD DEPTH
- FORK TRUCK BASE WITH MULTIPLE DRAWER ACCESS & ARE KEYPED DIFFERENT
- PARTITIONS AND DIVIDERS FACTORY INSTALLED

COUNTER HEIGHT (45^{3/16}"W x 29^{1/4}"D x 44"H)

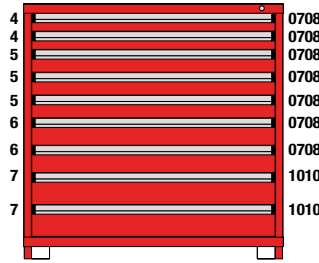

M1-452949FT-MD09AL
9 Drawers
254 Compartments

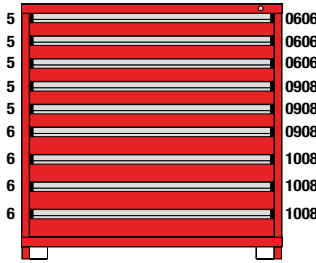

M1-452949FT-MD09CL
9 Drawers
267 Compartments

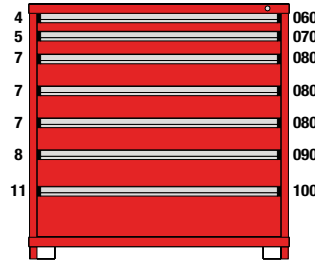

M1-452949FT-MD07BL
7 Drawers
196 Compartments

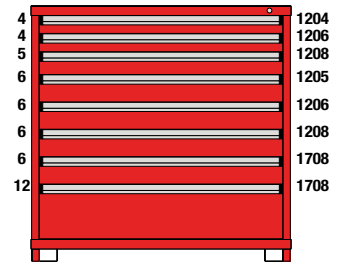

M1-452949FT-MD08AL
8 Drawers
152 Compartments

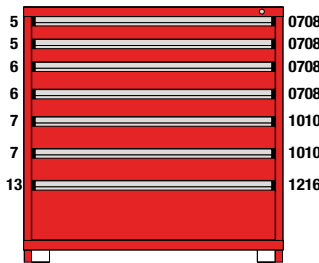

M1-452949FT-MD07CL
7 Drawers
166 Compartments

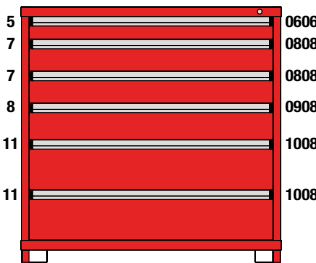

M1-452949FT-MD06AL
6 Drawers
155 Compartments

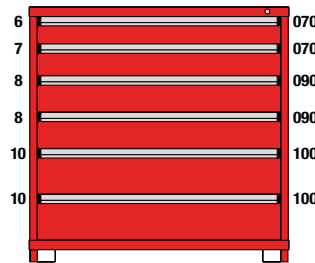

M1-452949FT-MD06BL
6 Drawers
152 Compartments

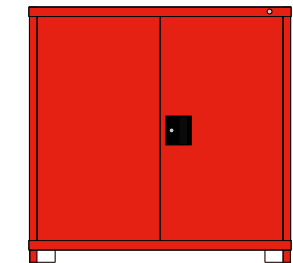

M1-452949FT-S2FHDN
Lockable swing door
Adjustable shelf
Lower fixed shelf

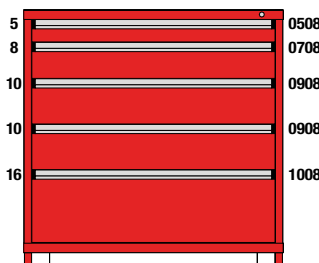

M1-452949FT-MD05AL
5 Drawers
140 Compartments

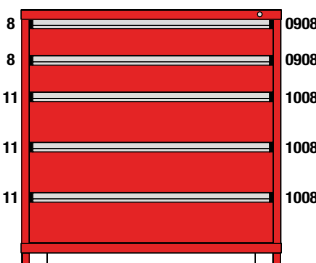

M1-452949FT-MD05CL
5 Drawers
108 Compartments

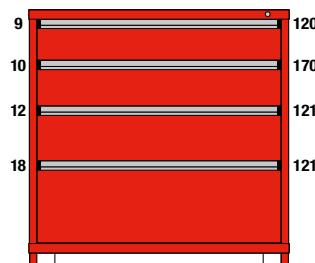

M1-452949FT-MD04AL
4 Drawers
44 Compartments

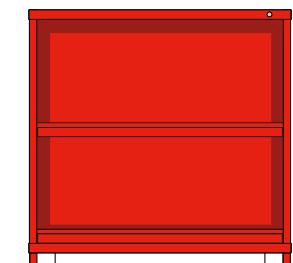

M1-452949FT-S2NDNN
Adjustable shelf
Lower fixed shelf

Drawer Number	4	5	6	7	8	9	10	11	12	13	14	15	16	17	18
Drawer Front	3 1/16"	3 7/8"	4 5/8"	5 7/16"	6 3/16"	7"	7 3/4"	8 9/16"	9 3/8"	10 1/8"	10 15/16"	11 3/4"	12 1/2"	13 5/16"	14 1/16"
Usable Height	2 1/4"	3 1/16"	3 7/8"	4 5/8"	5 7/16"	6 1/4"	7"	7 3/4"	8 9/16"	9 3/8"	10 1/8"	10 15/16"	11 3/4"	12 1/2"	13 5/16"

45 EXTRA WIDTH

ALL BORROUGHS PRE-CONFIGURED CABINETS FEATURE:

- 29 1/4" STANDARD DEPTH
- FORK TRUCK BASE WITH MULTIPLE DRAWER ACCESS & ARE KEYPED DIFFERENT
- PARTITIONS AND DIVIDERS FACTORY INSTALLED

STAND UP HEIGHT (45^{3/16}"W x 29^{1/4}"D x 37"H)

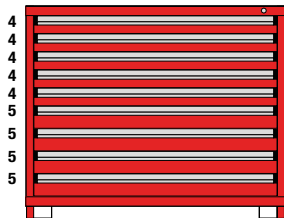

M1-452940FT-MD09AL
9 Drawers
252 Compartments

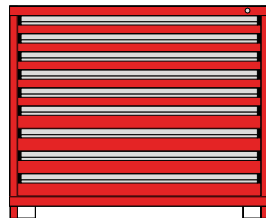

M1-452940FT-MD09BL
9 Drawers
237 Compartments

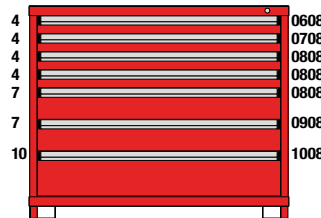

M1-452940FT-MD07AL
7 Drawers
196 Compartments

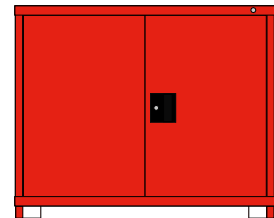

M1-452940FT-S2FHDN
Lockable swing door
Adjustable shelf
Lower fixed shelf

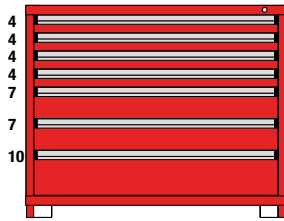

M1-452940FT-MD07BL
7 Drawers
204 Compartments

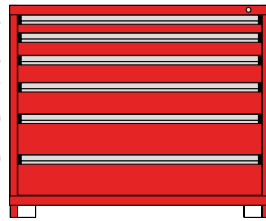

M1-452940FT-MD06AL
6 Drawers
155 Compartments

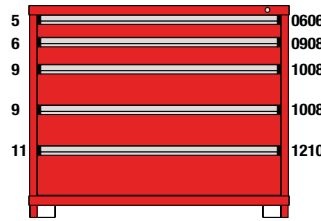

M1-452940FT-MD05AL
5 Drawers
111 Compartments

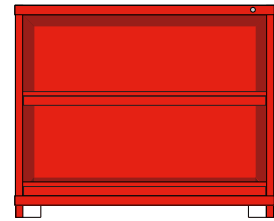

M1-452940FT-S2NDNN
Adjustable shelf
Lower fixed shelf

BENCH HEIGHT (30"W X 29^{1/4}"D X 33"H)

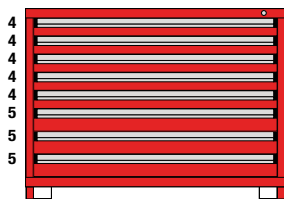

M1-452935FT-MD08BL
8 Drawers
261 Compartments

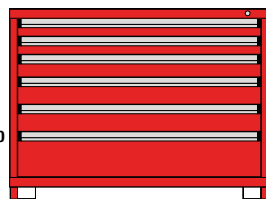

M1-452935FT-MD06AL
6 Drawers
204 Compartments

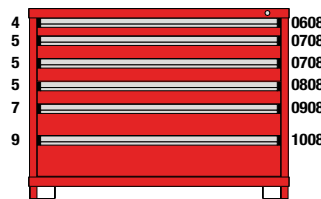

M1-452935FT-MD06CL
6 Drawers
172 Compartments

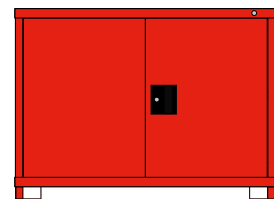

M1-452935FT-S2FHDN
Lockable swing door
Adjustable shelf
Lower fixed shelf

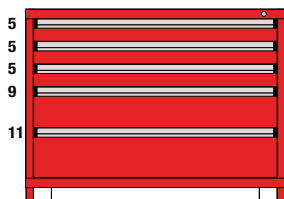

M1-452935FT-MD05BL
5 Drawers
126 Compartments

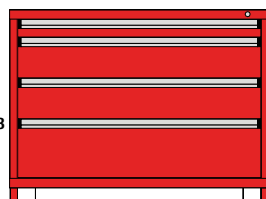

M1-452935FT-MD04AL
4 Drawers
103 Compartments

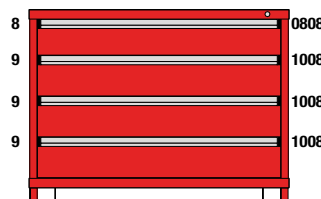

M1-452935FT-MD04BL
4 Drawers
88 Compartments

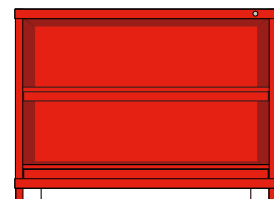

M1-452935FT-S2NDNN
Adjustable shelf
Lower fixed shelf

Drawer Number	4	5	6	7	8	9	10	11	12	13	14	15	16	17	18
Drawer Front	3 ^{1/16} "	3 ^{7/8} "	4 ^{5/8} "	5 ^{7/16} "	6 ^{3/16} "	7"	7 ^{3/4} "	8 ^{9/16} "	9 ^{3/8} "	10 ^{1/8} "	10 ^{15/16} "	11 ^{3/4} "	12 ^{1/2} "	13 ^{5/16} "	14 ^{1/16} "
Usable Height	2 ^{1/4} "	3 ^{1/16} "	3 ^{7/8} "	4 ^{5/8} "	5 ^{7/16} "	6 ^{1/4} "	7"	7 ^{3/4} "	8 ^{9/16} "	9 ^{3/8} "	10 ^{1/8} "	10 ^{15/16} "	11 ^{3/4} "	12 ^{1/2} "	13 ^{5/16} "

45 EXTRA WIDTH DRAWER INTERIOR LAYOUT KITS

ALL BORROUGHS PRE-CONFIGURED CABINETS FEATURE:

- 29 1/4" STANDARD DEPTH
- FORK TRUCK BASE WITH MULTIPLE DRAWER ACCESS & ARE KEYPED DIFFERENT
- PARTITIONS AND DIVIDERS FACTORY INSTALLED

DRAWER INTERIOR CONFIGURATIONS (40 1/4"W x 25 1/8"D CLEAR)

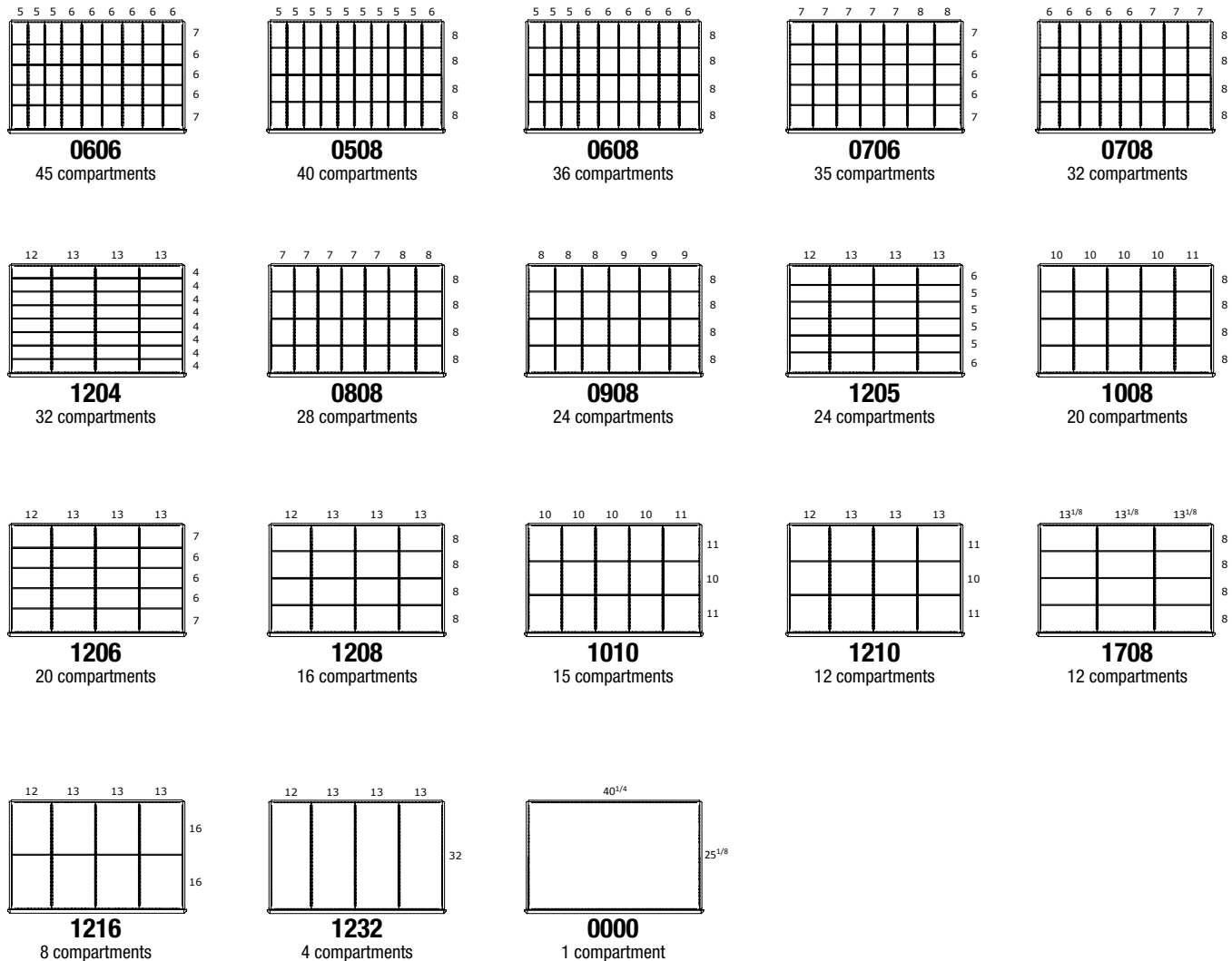

Modular drawers are the perfect fit for tool rooms looking for organization of frequently used equipment.

Compartment Size	3	4	5	6	7	8	9	10	11	12	13	14	15	16
Dimension (Clear)	1 7/8"	2 11/16"	3 1/2"	4 1/4"	5 1/16"	5 7/8"	6 11/16"	7 1/2"	8 1/4"	9 1/16"	9 7/8"	10 11/16"	11 1/2"	12 1/4"

60 DOUBLE WIDTH

ALL BORROUGHS PRE-CONFIGURED CABINETS FEATURE:

- 29 1/4" STANDARD DEPTH
- FORK TRUCK BASE WITH MULTIPLE DRAWER ACCESS & ARE KEYPED DIFFERENT
- PARTITIONS AND DIVIDERS FACTORY INSTALLED

EYE LEVEL (60^{3/8}"W x 29^{1/4}"D x 59"H)

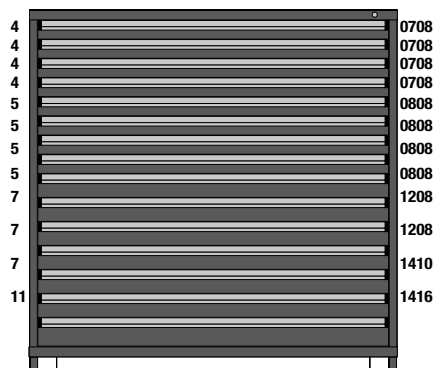

M1-602968FT-MD15AL
15 Drawers
543 Compartments

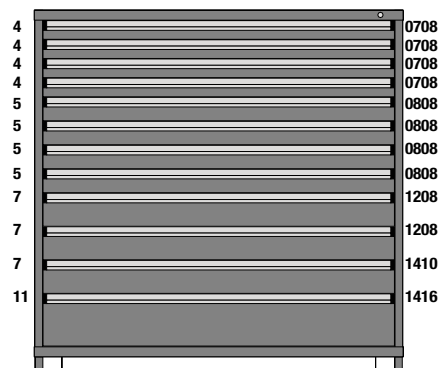

M1-602968FT-MD12BL
12 Drawers
377 Compartments

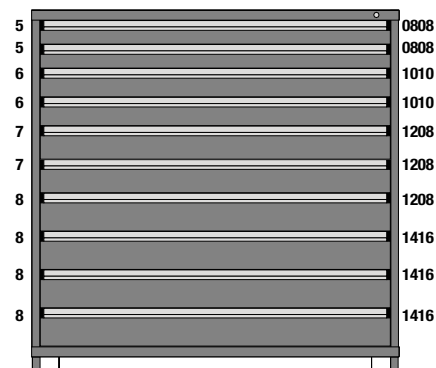

M1-602968FT-MD10BL
10 Drawers
216 Compartments

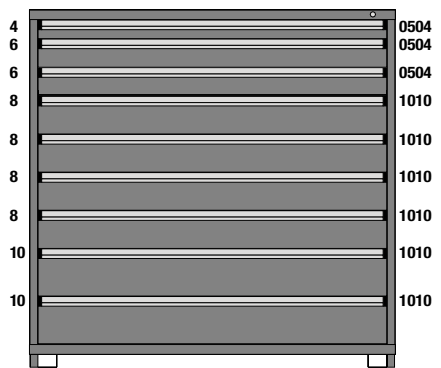

M1-602968FT-MD09CL
9 Drawers
378 Compartments

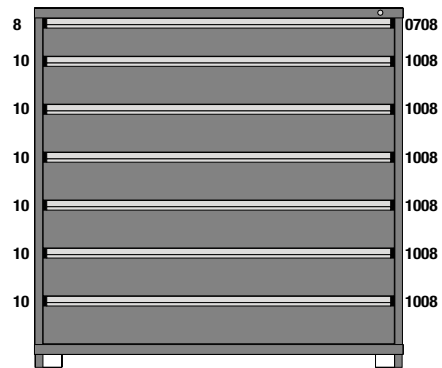

M1-602968FT-MD07AL
7 Drawers
208 Compartments

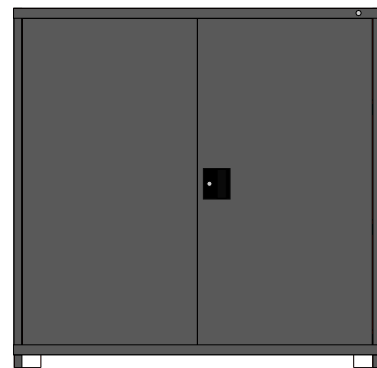

M1-602968FT-S3FHDN
Lockable swing door
Adjustable shelf (2)
Lower fixed shelf

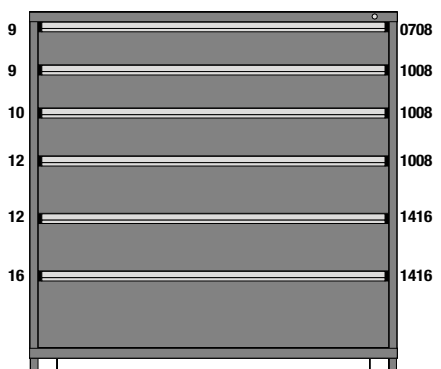

M1-602968FT-MD06AL
6 Drawers
144 Compartments

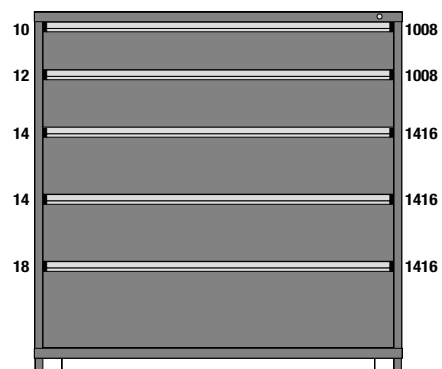

M1-602968FT-MD05AL
5 Drawers
86 Compartments

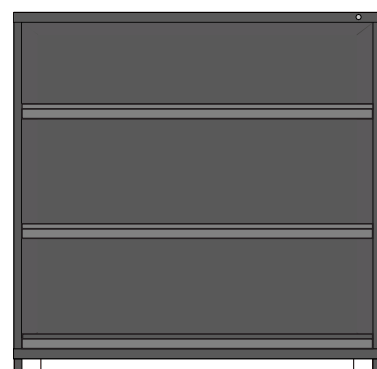

M1-602968FT-S3NDNN
Adjustable shelf (2)
Lower fixed shelf

Drawer Number	4	5	6	7	8	9	10	11	12	13	14	15	16	17	18
Drawer Front	3 ^{1/16} "	3 ^{7/8} "	4 ^{5/8} "	5 ^{7/16} "	6 ^{3/16} "	7"	7 ^{3/4} "	8 ^{9/16} "	9 ^{3/8} "	10 ^{1/8} "	10 ^{15/16} "	11 ^{3/4} "	12 ^{1/2} "	13 ^{5/16} "	14 ^{1/16} "
Usable Height	2 ^{1/4} "	3 ^{1/16} "	3 ^{7/8} "	4 ^{5/8} "	5 ^{7/16} "	6 ^{1/4} "	7"	7 ^{3/4} "	8 ^{9/16} "	9 ^{3/8} "	10 ^{1/8} "	10 ^{15/16} "	11 ^{3/4} "	12 ^{1/2} "	13 ^{5/16} "

60 DOUBLE WIDTH

ALL BORROUGHS PRE-CONFIGURED CABINETS FEATURE:

- 29 1/4" STANDARD DEPTH
- FORK TRUCK BASE WITH MULTIPLE DRAWER ACCESS & ARE KEYPED DIFFERENT
- PARTITIONS AND DIVIDERS FACTORY INSTALLED

COUNTER HEIGHT (60^{3/8}"W x 29^{1/4}"D x 44"H)



M1-602949FT-MD12AL
12 Drawers
24 Compartments

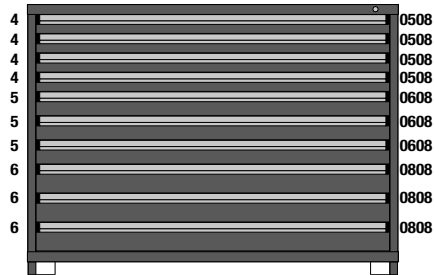

M1-602949FT-MD10AL
10 Drawers
464 Compartments



M1-602949FT-MD09AL
9 Drawers
396 Compartments

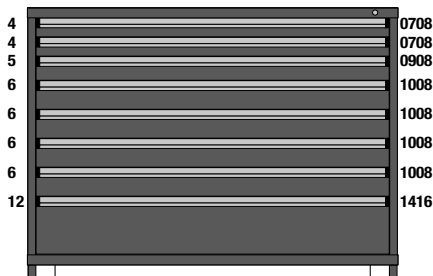

M1-602949FT-MD08AL
8 Drawers
234 Compartments

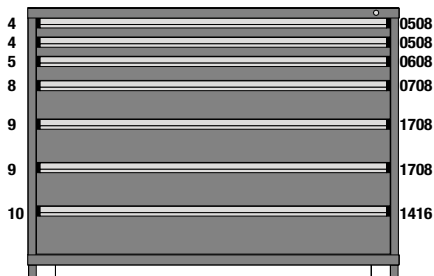

M1-602949FT-MD07AL
7 Drawers
238 Compartments

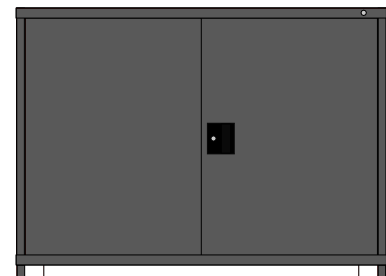

M1-602949FT-S2FHDN
Lockable swing door
Adjustable shelf
Lower fixed shelf

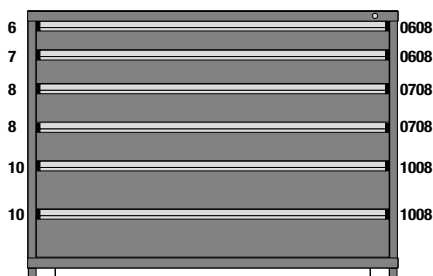

M1-602949FT-MD06AL
6 Drawers
224 Compartments

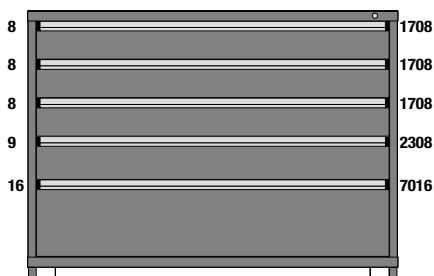

M1-602949FT-MD05AL
5 Drawers
62 Compartments



M1-602949FT-S2NDNN
Adjustable shelf
Lower fixed shelf

Drawer Table	Drawer Number	4	5	6	7	8	9	10	11	12	13	14	15	16	17	18
	Drawer Front	3 1/16"	3 7/8"	4 5/8"	5 7/16"	6 3/16"	7"	7 3/4"	8 9/16"	9 3/8"	10 1/8"	10 15/16"	11 3/4"	12 1/2"	13 5/16"	14 1/16"
	Usable Height	2 1/4"	3 1/16"	3 7/8"	4 5/8"	5 7/16"	6 1/4"	7"	7 3/4"	8 9/16"	9 3/8"	10 1/8"	10 15/16"	11 3/4"	12 1/2"	13 5/16"

60 DOUBLE WIDTH

ALL BORROUGHS PRE-CONFIGURED CABINETS FEATURE:

- 29 1/4" STANDARD DEPTH
- FORK TRUCK BASE WITH MULTIPLE DRAWER ACCESS & ARE KEYPED DIFFERENT
- PARTITIONS AND DIVIDERS FACTORY INSTALLED

STAND-UP HEIGHT (60^{3/8}"W x 29^{1/4}"D x 37"H)



M1-602940FT-MD09AL
9 Drawers
255 Compartments

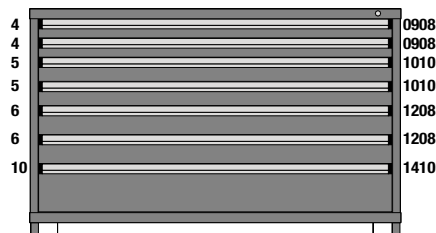

M1-602940FT-MD07AL
7 Drawers
169 Compartments

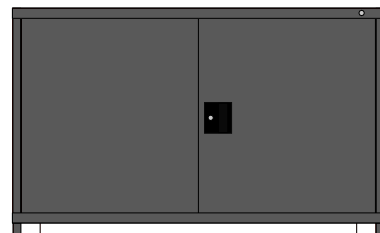

M1-602940FT-S2NDNN
Lockable swing door
Adjustable shelf
Lower fixed shelf

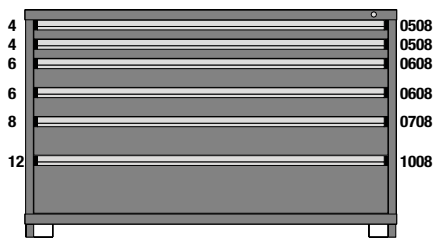

M1-602940FT-MD06AL
6 Drawers
268 Compartments

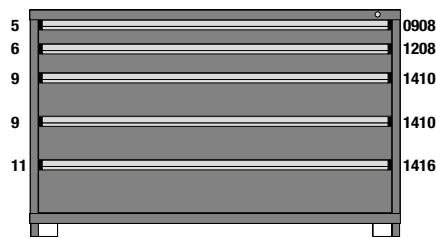

M1-602940FT-MD05AL
5 Drawers
96 Compartments



M1-602940FT-S2NDNN
Adjustable shelf
Lower fixed shelf

BENCH HEIGHT (60^{3/8}"W X 29^{1/4}"D X 33"H)

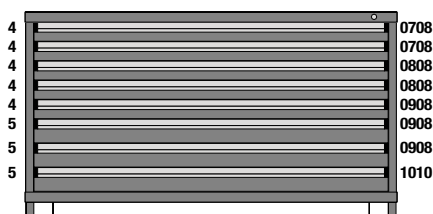

M1-602935FT-MD08AL
8 Drawers
269 Compartments

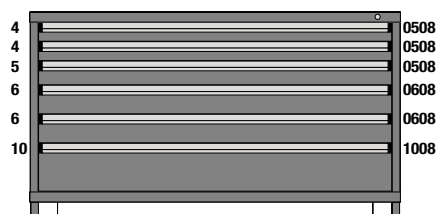

M1-602935FT-MD06AL
6 Drawers
284 Compartments

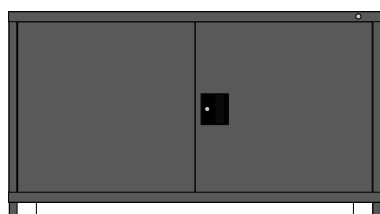

M1-602935FT-S2FHND
Lockable swing door
Adjustable shelf
Lower fixed shelf

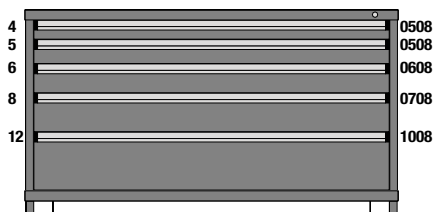

M1-602935FT-MD05AL
5 Drawers
224 Compartments

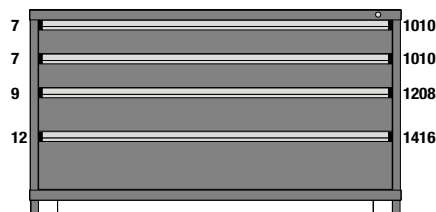

M1-602935FT-MD04AL
4 Drawers
76 Compartments

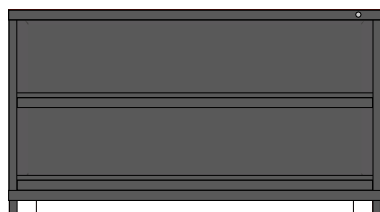

M1-602935FT-S2NDNN
Adjustable shelf
Lower fixed shelf

Drawer Number	4	5	6	7	8	9	10	11	12	13	14	15	16	17	18
Drawer Front	3 ^{1/16} "	3 ^{7/8} "	4 ^{5/8} "	5 ^{7/16} "	6 ^{3/16} "	7"	7 ^{3/4} "	8 ^{9/16} "	9 ^{3/8} "	10 ^{1/8} "	10 ^{15/16} "	11 ^{3/4} "	12 ^{1/2} "	13 ^{5/16} "	14 ^{1/16} "
Usable Height	2 ^{1/4} "	3 ^{1/16} "	3 ^{7/8} "	4 ^{5/8} "	5 ^{7/16} "	6 ^{1/4} "	7"	7 ^{3/4} "	8 ^{9/16} "	9 ^{3/8} "	10 ^{1/8} "	10 ^{15/16} "	11 ^{3/4} "	12 ^{1/2} "	13 ^{5/16} "

60 DOUBLE WIDTH DRAWER INTERIOR LAYOUT KITS

ALL BORROUGHS PRE-CONFIGURED CABINETS FEATURE:

- 29 1/4" STANDARD DEPTH
- FORK TRUCK BASE WITH MULTIPLE DRAWER ACCESS & ARE KEYPED DIFFERENT
- PARTITIONS AND DIVIDERS FACTORY INSTALLED

DRAWER INTERIOR CONFIGURATIONS (55 3/8"W x 25 1/8"D CLEAR)

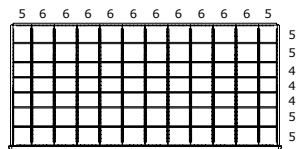

0504
84 compartments

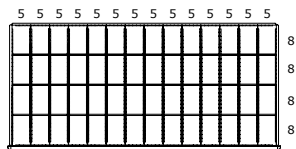

0508
56 compartments

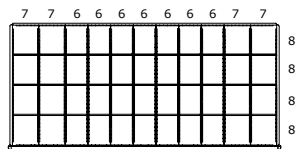

0608
44 compartments

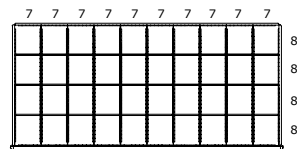

0708
40 compartments

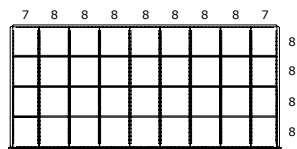

0808
36 compartments

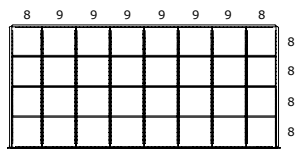

0908
32 compartments

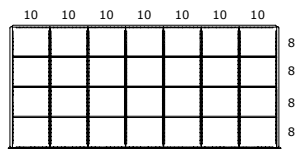

1008
28 compartments

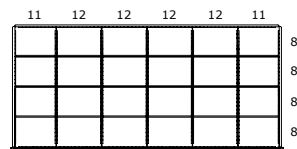

1208
24 compartments

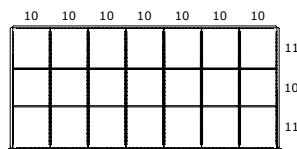

1010
21 compartments

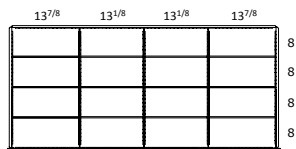

1708
16 compartments

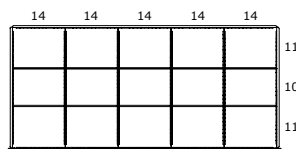

1410
15 compartments

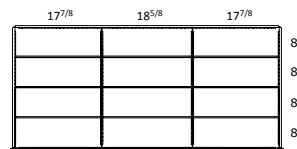

2308
12 compartments

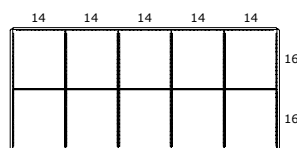

1416
10 compartments

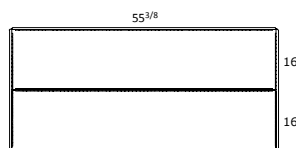

7016
2 compartments

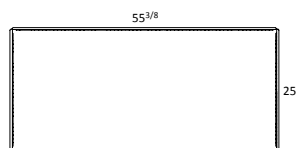

0000
1 compartment



Scan this QR Code to download **Modular Drawer** installation instructions

Numbers along the top and side of each drawer interior configuration refer to a specific compartment size. The corresponding dimensions are represented in the chart running along the bottom of the page.

Compartment Size	3	4	5	6	7	8	9	10	11	12	13	14	15	16
Dimension (Clear)	1 7/8"	2 11/16"	3 1/2"	4 1/4"	5 1/16"	5 7/8"	6 11/16"	7 1/2"	8 1/4"	9 1/16"	9 7/8"	10 11/16"	11 1/2"	12 1/4"

ACCESSORIES

HARDWOOD & STAINLESS STEEL TOPS



Hardwood Tops:

- 1³/₄" thick surface manufactured from mixed hardwoods.
- Features 1/8" eased edge with clear catalyzed lacquer finish.
- Includes all hardware and mounting instructions.
- Shipped pre-assembled when ordered with cabinet.

Stainless Tops:

- 16-Gauge stainless over industrial grade particle board core.
- 1⁵/₈" thick surface featuring wrapped and welded corners.
- Includes all hardware and mounting instructions.
- Shipped pre-assembled when ordered with cabinet.

PART #	Hardwood Tops Description
M1-02430HDW	Hardwood Top 24" W x 30" D
M1-03130HDW	Hardwood Top 31" W x 30" D
M1-04630HDW	Hardwood Top 46" W x 30" D
M1-06130HDW	Hardwood Top 61" W x 30" D

PART #	Stainless Tops Description
M1-02430SST	Stainless Steel Top 24" W x 30" D
M1-03130SST	Stainless Steel Top 31" W x 30" D
M1-04630SST	Stainless Steel Top 46" W x 30" D
M1-06130SST	Stainless Steel Top 61" W x 30" D

* Other widths available upon request.

FLUSH SWING DOORS



PART #	Door Description
M1-2327FH	Swing Door 23" W x 27S
M1-2331FH	Swing Door 23" W x 31S
M1-2335FH	Swing Door 23" W x 35S
M1-2340FH	Swing Door 23" W x 40S
M1-2349FH	Swing Door 23" W x 49S
M1-2368FH	Swing Door 23" W x 68S

PART #	Door Description
M1-4527FH	Swing Door 45" W x 27S
M1-4531FH	Swing Door 45" W x 31S
M1-4535FH	Swing Door 45" W x 35S
M1-4540FH	Swing Door 45" W x 40S
M1-4549FH	Swing Door 45" W x 49S
M1-4568FH	Swing Door 45" W x 68S

PART #	Door Description
M1-3027FH	Swing Door 30W x 27S
M1-3031FH	Swing Door 30" W x 31S
M1-3035FH	Swing Door 30" W x 35S
M1-3040FH	Swing Door 30" W x 40S
M1-3049FH	Swing Door 30" W x 49S
M1-3068FH	Swing Door 30" W x 68S

PART #	Door Description
M1-6027FH	Swing Door 60" W x 27S
M1-6031FH	Swing Door 60" W x 31S
M1-6035FH	Swing Door 60" W x 35S
M1-6040FH	Swing Door 60" W x 40S
M1-6049FH	Swing Door 60" W x 49S
M1-6068FH	Swing Door 60" W x 68S

- Reinforced multi-formed panel designed to be flush with the face of drawers.
- Black, full-height continuous hinge.
- Magnets hold door(s) when unlocked.

- Black, die-cast Pull Handle featuring 90 degree key rotation, 3-point locking system, and removable lock core (same core as cabinet lock).

- Not compatible with Drawers and Roll-Out Shelves.
- Shipped pre-assembled when ordered with cabinet.
- Default color = Drawer color.

ACCESSORIES

CASTER KITS



- Includes two (2) fixed casters and two (2) swivel casters with foot-activated brake.
- Includes push-pull tubular handle, hardware, and assembly instructions.
- Swivel casters feature "Total Lock" that locks both wheel and swivel in any position.
- 2" wide caster treads will not mar floors.
- 5" diameter features 500Lbs. capacity (2,000Lbs. total) & a 7^{1/2}" height gain.
- 6" diameter features 900Lbs. capacity (3,600Lbs. total) & a 8^{1/2}" height gain.
- 5" diameter features "Performa Rubber" tread in grey color.
- 6" diameter features "Polyurethane Hi-Tech" tread in burgundy color.
- Designed for field installation only, no drilling required.
- This kit is applicable to cabinets with Fork Truck Bases and Mobile Bases only.
- This kit is not recommended for cabinets taller than "Stand Up Height" (37").

PART #	Description
M1-29MB5	Mobile Base Kit 5"Dia x 29D
M1-29MB6	Mobile Base Kit 6"Dia x 29D

EXTERNAL LOCK BARS



- Utilized in mobile and high-risk applications.
- Holds all drawers closed, lift and rotate to open.
- Can secure all drawers with a single padlock (padlock not included).
- Can be mounted to either left or right side of cabinet.
- Shipped pre-assembled when ordered with cabinet, requires drilling when field assembled.
- Default color = Housing.



PART #	Description WxD
M1-27ELB	External Locking Bar 27S
M1-31ELB	External Locking Bar 31S
M1-35ELB	External Locking Bar 35S
M1-40ELB	External Locking Bar 40S
M1-49ELB	External Locking Bar 49S
M1-68ELB	External Locking Bar 68S

REMOVABLE LOCK CORES, KEYS, PLUG



- All lock cylinders feature a removable core. Providing easy re-keying without taking the unit apart. Lock cores & keys are stamped with the key code number.
- The lock core is available in 2,000 different key codes.

PART #	Description
M1-LOCK-CORE	Removable Lock Core includes 2-keys (specify lock code from 26001 to 26050)
M1-KEY-REMOVAL	Core Removal Key (required for core removal and insertion)
M1-KEY	Key (specify lock code from 26001 to 26050)
M1-KEY-MASTER	Master Key

RIBBED RUBBER RETAINER TOPS



- 1/8" thick, ribbed non-skid, grease resistant pliable rubber.
- Black colored mat pre-cut fit.
- Back Stop and Side Stops (LH & RH), provides 1"H lip on sides and back of cabinet retaining items from rolling off.
- Shipped pre-assembled when ordered with cabinet.

PART #	W x D
M1-2329RRRT	23" x 29"
M1-3029RRRT	30" x 29"
M1-4529RRRT	45" x 29"
M1-6029RRRT	60" x 29"



ACCESSORIES

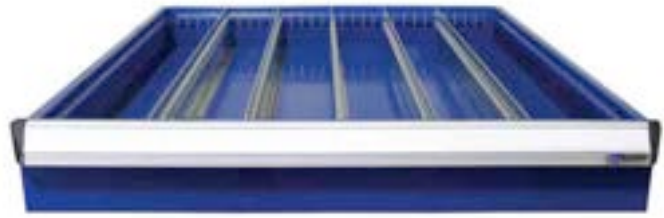

DRAWER PARTITIONS (FRONT TO BACK)

Divides the drawer along its depth, adjustable every 20mm (0.799") center to center. Fabricated in galvanized steel (G60 finish) and requires two (2) self-tapping screws for attachment (part# MDC-0705).

Drawer Height						
Drawer Depth Clear (nominal)	Part Number for 4S Drawers (1-15/16"H)	Part Number for 5S, 6S, 7S Drawers (2-15/16"H)	Part Number for 8S, 9S Drawers (4-15/16"H)	Part Number for 10S, 11S, 12S Drawers (6-11/16"H)	Part Number for 13S, 14S, 15S Drawers (8-15/16"H)	Part Number for 16S, 17S, 18S Drawers (11-7/16"H)
25-1/8" (29D)	M1-02H-32P	M1-03H-32P	M1-05H-32P	M1-07H-32P	M1-09H-32P	M1-12H-32P



DRAWER PARTITIONS (SIDE TO SIDE)

Divides the drawer along its width, adjustable every 20mm (0.799") center to center. Fabricated in galvanized steel (G60 finish) and requires two (2) self-tapping screws for attachment (part# MDC-0705).

Drawer Height						
Drawer Width Clear (nominal)	Part # for 4S Drawers (1-15/16"H)	Part # for 5S, 6S, 7S Drawers (2-15/16"H)	Part # for 8S, 9S Drawers (4-15/16"H)	Part # for 10S, 11S, 12S Drawers (6-11/16"H)	Part # for 13S, 14S, 15S Drawers (8-15/16"H)	Part # for 16S, 17S, 18S Drawers (11-7/16"H)
17-7/8" (23W)	M1-02H-23P	M1-03H-23P	M1-05H-23P	M1-07H-23P	M1-09H-23P	M1-12H-23P
25-1/8" (30W)	M1-02H-32P	M1-03H-32P	M1-05H-32P	M1-07H-32P	M1-09H-30P	M1-12H-32P
40-1/4" (45W)	M1-02H-51P	M1-03H-51P	M1-05H-51P	M1-07H-51P	M1-09H-51P	M1-12H-51P
55-3/8" (60W)	M1-02H-70P	M1-03H-70P	M1-05H-70P	M1-07H-70P	M1-09H-70P	M1-12H-70P

ROLL-OUT SHELVES

- Easy access to large, bulky items.
- Supports even loads of 400 lbs.
- Adjustable on 20mm vertical increments.
- Drawer front is notched to allow flush access to top of reinforcing channels.
- Four (4) sizes, designed to fit Housing widths of 23W, 30W, 45W, 60W and in a housing depth of 29D.



PART#	W x D
M1-2329R	Roll Out 23" W x 29" D
M1-3029R	Roll Out 30" W x 29" D
M1-4529R	Roll Out 45" W x 29" D
M1-6029R	Roll Out 60" W x 29" D



ACCESSORIES



DRAWER DIVIDERS (SIDE TO SIDE)

Divides the drawer along its width, adjustable every 20mm (0.799") center to center. Fabricated in galvanized steel (G60 finish) and requires two (2) self-tapping screws for attachment (part# **MDC-0705**).

Drawer Height						
Compartment Size Clear (nominal)	Part # for 4S Drawers (1-15/16"H)	Part # for 5S, 6S, 7S Drawers (2-15/16"H)	Part # for 8S, 9S Drawers (4-15/16"H)	Part # for 10S, 11S, 12S Drawers (6-11/16"H)	Part # for 13S, 14S, 15S Drawers (8-15/16"H)	Part # for 16S, 17S, 18S Drawers (11-7/16"H)
1-7/8" (3S)	M1-02H-03D	M1-03H-03D	M1-05H-03D	M1-07H-03D	M1-09H-03D	M1-12H-03D
2-11/16" (4S)	M1-02H-04D	M1-03H-04D	M1-05H-04D	M1-07H-04D	M1-09H-04D	M1-12H-04D
3-1/2" (5S)	M1-02H-05D	M1-03H-05D	M1-05H-05D	M1-07H-05D	M1-09H-05D	M1-12H-05D
4-1/4" (6S)	M1-02H-06D	M1-03H-06D	M1-05H-06D	M1-07H-06D	M1-09H-06D	M1-12H-06D
5-1/16" (7S)	M1-02H-07D	M1-03H-07D	M1-05H-07D	M1-07H-07D	M1-09H-07D	M1-12H-07D
5-7/8" (8S)	M1-02H-08D	M1-03H-08D	M1-05H-08D	M1-07H-08D	M1-09H-08D	M1-12H-08D
6-11/16" (9S)	M1-02H-09D	M1-03H-09D	M1-05H-09D	M1-07H-09D	M1-09H-09D	M1-12H-09D
7-1/2" (10S)	M1-02H-10D	M1-03H-10D	M1-05H-10D	M1-07H-10D	M1-09H-10D	M1-12H-10D
8-1/4" (11S)	M1-02H-11D	M1-03H-11D	M1-05H-11D	M1-07H-11D	M1-09H-11D	M1-12H-11D
9-1/16" (12S)	M1-02H-12D	M1-03H-12D	M1-05H-12D	M1-07H-12D	M1-09H-12D	M1-12H-12D
9-7/8" (13S)	M1-02H-13D	M1-03H-13D	M1-05H-13D	M1-07H-13D	M1-09H-13D	M1-12H-13D
10-11/16" (14S)	M1-02H-14D	M1-03H-14D	M1-05H-14D	M1-07H-14D	M1-09H-14D	M1-12H-14D
12-1/4" (16S)	M1-02H-16D	M1-03H-16D	M1-05H-16D	M1-07H-16D	M1-09H-16D	M1-12H-16D
13-1/8" (17S)	M1-02H-17D	M1-03H-17D	M1-05H-17D	M1-07H-17D	M1-09H-17D	M1-12H-17D
13-7/8" (18S)	M1-02H-18D	M1-03H-18D	M1-05H-18D	M1-07H-18D	M1-09H-18D	M1-12H-18D
17-7/8" (23S)	M1-02H-23D	M1-03H-23D	M1-05H-23D	M1-07H-23D	M1-09H-23D	M1-12H-23D
18-5/8" (24S)	M1-02H-24D	M1-03H-24D	M1-05H-24D	M1-07H-24D	M1-09H-24D	M1-12H-24D

STATIC SHELVES



- Reinforced pan designed to support a load capacity of 400Lbs.
- Adjustable on 3/4" vertical centers.
- Features a clear depth of 25" and clear widths of: 21-1/4" (23W), 28-7/16" (30W), 43-5/8" (45W), 58-13/16" (60W).
- Features a 3/4"H vertical lip along both sides and back.
- Includes galvanized Shelf Supports and plastic locating Rivets.
- Shipped pre-assembled when ordered with cabinet.
- Default = Housing color.

PART #	W x D
M1-2329S	Static Shelf 23" W x 29" D
M1-3029S	Static Shelf 30" W x 29" D
M1-4529S	Static Shelf 45" W x 29" D
M1-6029S	Static Shelf 60" W x 29" D



Scan this QR Code to download **Modular Drawer** installation instructions



MINI-MEZZANINE CONFIGURATION

MINI-MEZZANINE SYSTEMS - SAVING FLOOR SPACE WITH STACKABLE UNITS

Borroughs new Mini-Mezzanine Systems offer big time storage capacity in a small compact foot print. These systems are perfect for businesses looking to utilize vertical space where floor space is at a premium. Used widely in facilities maintenance areas, warehouses, and distribution centers - these mezzanines are self-supported, and provide an ample supply of storage for small parts and/or products.

FEATURES:

- A self-supporting mezzanine system utilizing the Borroughs 30" wide x 29" deep Eye-level Modular Drawer Cabinets (w/ forklift base).
- Construction consists of a Staircase, End Guards, and 60" wide pre-configured deck sections
- 3/16" thick diamond plate steel on decking and staircase.
- The deck surface features welded tubular pockets for field attachment of welded handrails.
- All handrail is constructed from 2" square, 16 gauge wall structural tubing, with black plastic end caps.
- Optional shelf cabinets can be added to tops of upper cabinets to enhance storage capacity for bulky items.

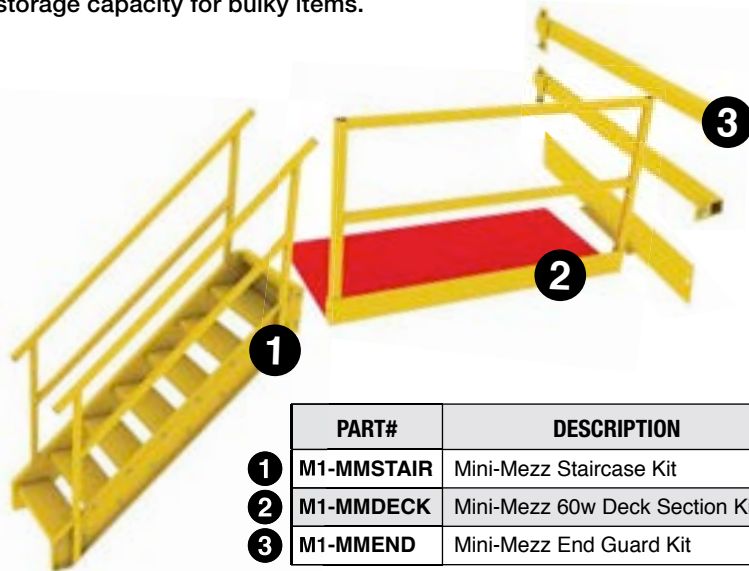

	PART#	DESCRIPTION
1	M1-MMSTAIR	Mini-Mezz Staircase Kit
2	M1-MMDECK	Mini-Mezz 60w Deck Section Kit
3	M1-MMEND	Mini-Mezz End Guard Kit

• Available in seven (7) standard colors and (49) possible color combinations. Handrail can be different color.

SAMPLE CONFIGURATIONS

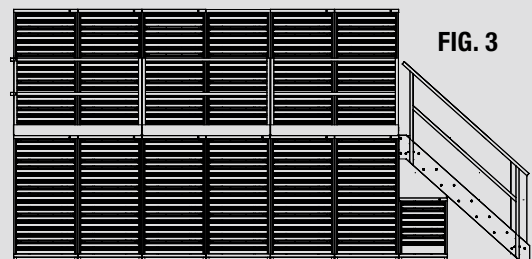
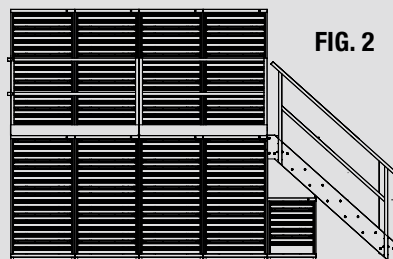
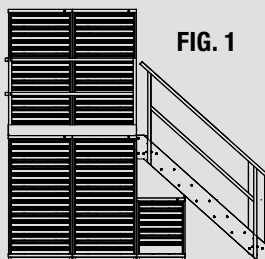



FLEXI-BIN®

Take Control of Your Small Inventory Stock.

Flexi-Bins are a tried and true, economic way to store items ranging from electrical components, small parts, tools and hardware to literature, binders and small boxes. The shallow shelf depth of 12" keeps small items in sight. The sliding dividers and modular design allow you access to small parts and storage items instantly and easily. Sliding dividers adjust horizontally, and self-locking shelves can be raised and lowered without disturbing shelf contents for even greater time saving convenience. Flexi-Bins standard white back panels improve picking visibility and efficiency. Optional trim panels are available for a finished appearance. Install Flexi-Bins as stand-alone units or in back-to-back rows. Today, Flexi-Bins are a favorite among auto part stores, distribution outlets and retail operations. For improved inventory control and organization it's impossible to beat the functionality and value of Flexi-Bins.



Scan this QR Code to
download *Flexi-Bin*
installation instructions

FLEXI-BINS®



(01)



(02)



(03)



(04)



(05)



(06)



(07)

PRE-CONFIGURED UNITS

Flexi-Bins allow parts to remain in proper sequence for quick identification and retrieval. Inventory control is increased and parts personnel are more efficient.



FB101



FB102



FB103



FB104



FB105



FB106



FB107



FB108

PART#	W x D x H	Adjustable Openings	Shelves	Sliding Dividers, 3" H	Sliding Dividers, 6" H
FB101	38"W x 12"D x 84"H	7	6	–	–
FB102	38"W x 12"D x 84"H	9	8	–	–
FB103	38"W x 12"D x 84"H	11	10	–	–
FB104	38"W x 12"D x 84"H	21	6	–	14
FB105	38"W x 12"D x 84"H	41	8	32	–
FB106	38"W x 12"D x 84"H	51	10	40	–
FB107	38"W x 12"D x 84"H	43 (+12 drawers)	10	28	6
FB108	38"W x 12"D x 84"H	0 (108 drawers)	17	–	–

COMPONENTS & ACCESSORIES

FLEXI-BIN SLIDING SHELF DIVIDERS

Sliding dividers create shelf compartments perfectly sized for your inventory. The formed-in label holder travels with the divider when parts are rearranged.



14
GAUGE
STEEL



The patented formed-in label holder travels with the divider when parts are rearranged.

Shelves adjust on 1-1/2" increments and lock in place automatically.

PART #	Description
14066-000	1 1/2" Sliding Shelf Divider
14066-001	3" Sliding Shelf Divider
14066-002	4 1/2" Sliding Shelf Divider
14066-003	6" Sliding Shelf Divider

ADDITIONAL COMPONENTS

PART #	Description
02720-099	Slide-in Shelf
04432-099	Drawer
04436-099	Drawer Divider
09656-094	Full Length Label Holder
08897-099	Blank Labels (240/pkg.)
13100-000	84" Single Face Trim Panel
13101-000	84" Double Face Trim Panel



FLEXI-BIN FRAMES



PART #	W x D x H
PBF-12-84	38"w x 12"d x 84"h
PBF-12-96	38"w x 12"d x 96"h

POST FOOT ANGLE

For anchoring angle posts to the floor.



14
GAUGE
STEEL

PART #	Description
08702-829	Post Foot Angle



Flexi-Bins used along with a bar coding system helps give accurate, up-to-date inventory control. This provides customers with a faster, more enjoyable experience with your parts department.

INSTALLATION EXAMPLES



Originally designed for automotive parts departments, Flexi-Bins are sturdy enough to support a second level.



Available Flexi-Bin drawers (dividers optional) are equipped with a backstop that prevents accidental removal.



Automotive parts are stored properly in Flexi-Bins, catalog #FB101.



Flex-Bins shelving capacity of 150 lbs. per shelf allows for great versatility in the products that can be stored on these systems.

SHOP EQUIPMENT

- (01)
- (02)
- (03)
- (04)
- (05)
- (06)
- (07)

SHOP EQUIPMENT

Professional Products – Forged to Withstand the Toughest Environments.

Borroughs has a long history of making the best shop equipment in the industry. We started manufacturing shop equipment in the late 1940's and many of those items are still in use today. Our shop equipment offerings include work benches, technician carts, professional work stations, wall mounted cabinets, tool boxes, modular drawer cabinets, racks and specialty desks. Each of these products combines heavy duty construction with superior fit and finish and includes a 5 Year Limited Warranty. American made – and the highest quality.



WTL 200 Series Benches offer great, enclosed storage for automotive professionals.



Scan this QR Code to download
WB 100 Series Work Bench
installation instructions.

WORK BENCHES

Whether you need a basic open leg work bench or a complete integrated workstation, Borroughs has a work bench to fit your needs. Borroughs work benches are constructed of heavy gauge steel and are designed for durability. Work benches can be customized by adding accessories.

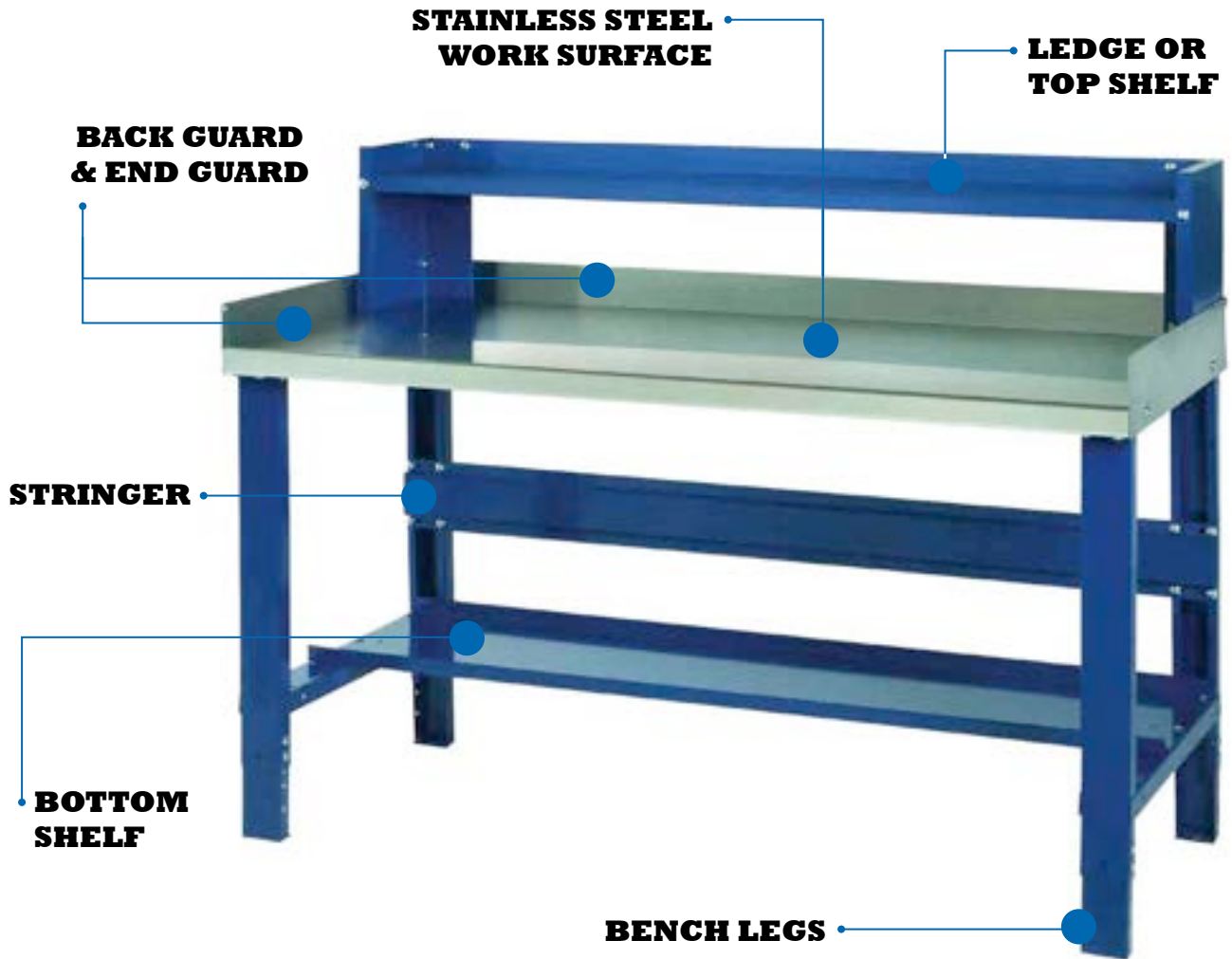

BORROUGHS BENCH TOP SELECTIONS (see page 114 for details)

- MT – Solid Hard Wood Top
- LM – Laminate Top
- RL – Radius Edge Laminate top
- MD – Multi-Duty Wood Top
- SD – Static Dissipative Top
- PW – Pressed Wood on Steel Top
- SS – Stainless Steel Top

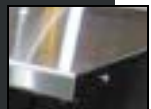

Having trouble choosing a work bench for your needs? Contact our Customer Service Team today. We will help work with you get the right bench for your needs. **1-800-748-0227 x4801**

PRECONFIGURED WORK BENCHES

All open work benches include a steel top. To order with a stainless steel top, just add "SS" to the end of the catalog number. To order other upgraded tops—contact your account representative.



See following pages for various work bench components and their individual gauges of steel.



100 SERIES

PART #	W x D
WB100	48" x 28"
WB101	48" x 34"
WB102	60" x 28"
WB103	60" x 34"
WB104	72" x 28"
WB105	72" x 34"



120 SERIES

PART #	W x D
WB120	48" x 28"
WB121	48" x 34"
WB122	60" x 28"
WB123	60" x 34"
WB124	72" x 28"
WB125	72" x 34"



130 SERIES

PART #	W x D
WB130	48" x 28"
WB131	48" x 34"
WB132	60" x 28"
WB133	60" x 34"
WB134	72" x 28"
WB135	72" x 34"



160 SERIES

PART #	W x D
WB160	48" x 28"
WB161	48" x 34"
WB162	60" x 28"
WB163	60" x 34"
WB164	72" x 28"
WB165	72" x 34"

PORTABLE KIT

Consists of foot supports and four easy-rolling 4" diameter casters (two are braking). Stems are easily bolted to foot plates with special threaded stems, and can be attached to a Borroughs Bench at any time to provide complete mobility.

400 lb. capacity each caster



PART #	Size
14845-000	4" diameter

SEMI-PORTABLE KIT

Kit includes two wheels with leg cleat and two handles for opposite end of bench. Leg, with wheel assembly, is adjusted to a shorter position than handle end. The handles telescope.



PART #	Size
14854-000	28" and 34"

LEVELING SCREW

Allows for easy height adjustment and leveling of the unit on irregular and uneven surfaces. Each leg adjusts independently without having to tip the unit. Sold in pairs.



PART #	Description
14825-000	Leveling Screw

COMPONENTS & ACCESSORIES

LEDGE OR TOP SHELF

Keeps tool boxes, testing equipment, etc., off working surface. Pierced for bolting to back guard or top. Can be tiered to provide shelf-on-shelf arrangement.

16
GAUGE
STEEL



PART #	W x H
14851-000	48" x 10"
14851-001	60" x 10"
14851-002	72" x 10"

STRINGER

Eliminates sway and adds rigidity to work bench. Attaches to the back two legs. May also be used as a shelf backstop. Stringer is 5" high with 3/4" flanges. One required for each bench.

18
GAUGE
STEEL



PART #	WIDTH
14827-000	48"
14827-001	60"
14827-002	72"

FOOT REST

Use in place of a bottom shelf on open work benches, adding extra rigidity. Bolted to cross rails of leg assemblies - box channel design.

16
GAUGE
STEEL



PART #	WIDTH
14879-000	48"
14879-001	60"
14879-002	72"

BOTTOM SHELF

Made of heavy-gauge steel, 15" deep, with a formed lip in front and a 1" flange in back. Attaches to cross rails of work bench legs.

16
GAUGE
STEEL



PART #	W x D
14826-000	48" x 15"
14826-001	60" x 15"
14826-002	72" x 15"

ENCLOSURE PANELS

Encloses bench for protection of stored materials.

22
GAUGE
STEEL



PART #	W x H
BACK PANEL	
14853-000	48" x 21"
14853-001	60" x 21"
14853-002	72" x 21"
END PANEL (SETS OF TWO)	
14852-000	28" x 34"

WORK BENCH LEG

The Borroughs work bench leg allows for height adjustment from 27^{1/2}" to 36" on 1" centers (first adjustment 1^{1/2}"). Work surfaces can be set at most comfortable height to reduce fatigue and improve productivity. In the future, benches can be reconfigured as personnel turn over or the needs of your business change. Fits 28" and 34" benches.

PART #	Size
14828-000	Adjustable height 27 1/2" to 36"

BACK GUARD & END GUARD

Back guards prevent material from falling off bench at rear. Project 3" above bench top and are punched for bolting to bench top and ends.

14
GAUGE
STEEL



PART #	WIDTH
BACK GUARD	
14824-000	48"
14824-001	60"
14824-002	72"
END GUARD (SETS OF TWO)	
14822-000	28"
14822-001	34"

STAINLESS STEEL BACK GUARD ASSEMBLY

PART #	WIDTH
14818-003-000	48"
14818-004-000	60"
14818-005-000	72"

STAINLESS STEEL END GUARD ASSEMBLY

PART #	DEPTH
14822-003-00	28"



16
GAUGE
STEEL



WORK BENCH TOPS

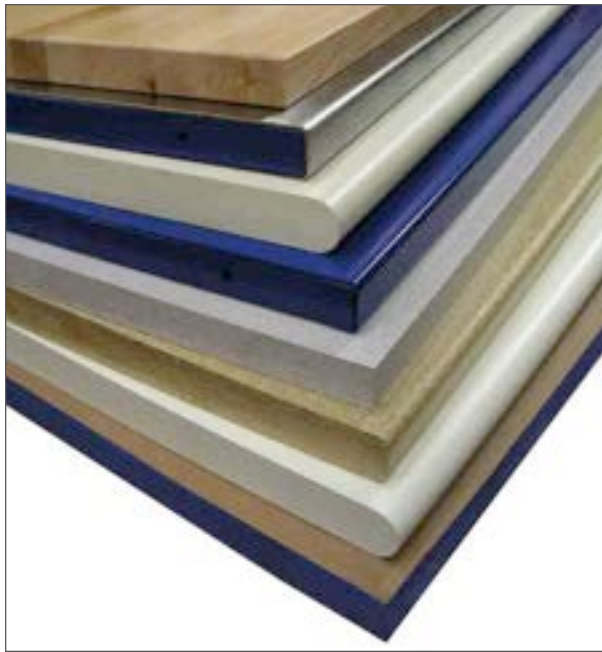

Your choice of work bench tops is essential for maximum safety and performance. Our range of top materials has been selected specifically to provide the flexibility you need.

STAINLESS STEEL TOPS

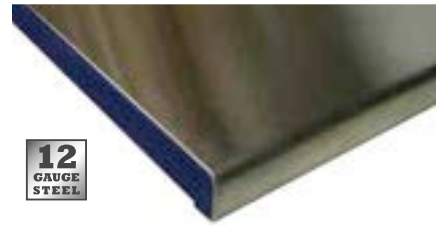

Heavy gauge stainless steel tops with channel formations front and rear. Includes stringer.

PART#	W x D x H
14820-S03	48" x 28"
14856-S02	60" x 28"
14857-S02	72" x 28"

SOLID HARD WOOD TOPS



Ideal for electrical, woodworking, tool-making and instrument work. Sanded satin smooth and has a lacquer finish.

PART#	W x D x H
00428-061	48" x 28" x 1 3/4"
00434-061	48" x 34" x 1 3/4"
00528-061	60" x 28" x 1 3/4"
00534-061	60" x 34" x 1 3/4"
00628-061	72" x 28" x 1 3/4"
00634-061	72" x 34" x 1 3/4"

PRESSED WOOD ON STEEL TOPS



Facing of 1/8" treated hardboard in natural finish bonded to a standard steel top. Includes stringer.

PART#	W x D x H
14883-000	48" x 28" x 1 7/8"
14883-001	48" x 34" x 1 7/8"
14883-002	60" x 28" x 1 7/8"
14883-003	60" x 34" x 1 7/8"
14883-004	72" x 28" x 1 7/8"
14883-005	72" x 34" x 1 7/8"

MULTI-DUTY WOOD TOPS



A warp-and splinter-proof top made of composite wood core and faced on both sides with tempered hardboard.

PART#	W x D x H
00428-062	48" x 28" x 1 3/4"
00434-062	48" x 34" x 1 3/4"
00528-062	60" x 28" x 1 3/4"
00534-062	60" x 34" x 1 3/4"
00628-062	72" x 28" x 1 3/4"
00634-062	72" x 34" x 1 3/4"

STATIC DISSIPATIVE TOPS

Top is composed of special static dissipative almond-colored high pressure laminate, with a rounded front edge, over medium density industrial-grade particle board.



PART#	W x D x H
11019-000	48" x 28" x 1 3/4"
11019-001	48" x 34" x 1 3/4"
11010-002	60" x 28" x 1 3/4"

PART#	W x D x H
11019-003	60" x 34" x 1 3/4"
11019-004	72" x 28" x 1 3/4"
11019-005	72" x 34" x 1 3/4"

WORK BENCH TOPS

STEEL TOPS



12
GAUGE
STEEL

Heavy-duty steel top which won't absorb oil or dirt. Features channel formations front and rear. Includes stringer.

PART#	W x D x H
14881-S00	48" x 28" x 1 3/4"
14881-S01	48" x 34" x 1 3/4"
14881-S02	60" x 28" x 1 3/4"
14881-S03	60" x 34" x 1 3/4"
14881-S04	72" x 28" x 1 3/4"
14881-S05	72" x 34" x 1 3/4"

LAMINATE TOPS



High pressure laminate in a grey linen-look finish over medium density industrial-grade particle board.

PART#	W x D x H
11020-000	48" x 28" x 1 5/8"
11020-001	48" x 34" x 1 5/8"
11020-002	60" x 28" x 1 5/8"
11020-003	60" x 34" x 1 5/8"
11020-004	72" x 28" x 1 5/8"
11020-005	72" x 34" x 1 5/8"

RADIUS LAMINATE TOPS

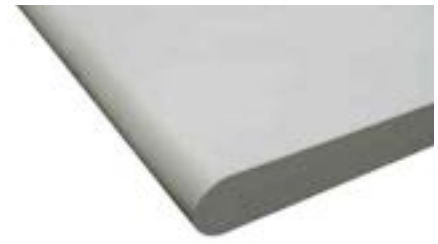

Almond colored high pressure laminate over industrial grade particle board. Radius front edge provides improved aesthetics and user comfort.

PART#	W x D x H
11018-000	48" x 28" x 1 3/4"
11018-001	48" x 34" x 1 3/4"
11018-002	60" x 28" x 1 3/4"
11018-003	60" x 34" x 1 3/4"
11018-004	72" x 28" x 1 3/4"
11018-005	72" x 34" x 1 3/4"



WALL MOUNTED SHOP PRODUCTS

WALL MOUNT BENCH

Borroughs' wall mount bench fastens directly to the wall and needs no contact with the floor. No legs get in the way or create hard to reach places where dirt and refuse collect.



PART #	W x D
WMB300	48" x 28"
WMB302	60" x 28"
WMB304	72" x 28"
WMB305	72" x 34"

Scan this QR Code to download Wall Mounted Work Bench installation instructions.



WALL MOUNT CABINET

Mounts conveniently to walls. Swing doors and adjustable center shelf maximize efficient storage space. Key lock for security. Shown with standard top.



16 GAUGE STEEL

PART #	W x D x H
11114-000	36" x 13" x 27"

WALL MOUNT LEG

Wall mount leg is available for existing or custom bench tops. Sold in pairs and requires steel attachment channels for use with wood or laminate tops.



PART #	Size
Wall Mount Leg	
11000-000	28" & 34" deep
Steel Attachment for Wall Mount Leg	
14813-000	28"
14813-001	34"

WALL MOUNT CABINET ANGLED TOP KIT



16 GAUGE STEEL

PART #	W x D x H
11125-000	36" x 13" x 6"

UPPER CABINETS

- Strongest cabinets in the industry
- Tip-Up, slide in doors allow single-hand operation
- Soft close feature helps longevity of cabinets
- Can be mounted atop riser frame or can be wall mounted

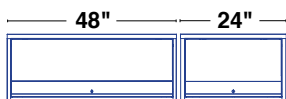

Sample configuration

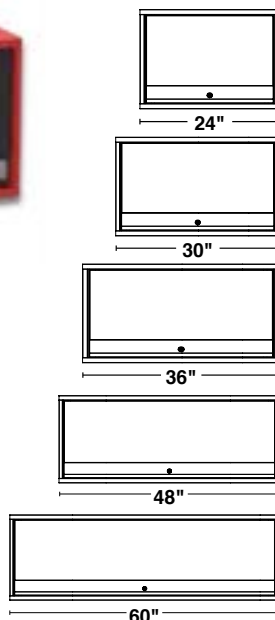

PART #	Description – W x D x H
A1-241819UPC	Upper Cabinet 24" x 18" x 19"
A1-301819UPC	Upper Cabinet 30" x 18" x 19"
A1-361819UPC	Upper Cabinet 36" x 18" x 19"
A1-481819UPC	Upper Cabinet 48" x 18" x 19"
A1-601819UPC	Upper Cabinet 60" x 18" x 19"

*Upper Cabinets can also be mounted to wall, rather than using riser frame.

TECHNICIAN BENCHES

TAPER LEG ENCLOSED BENCHES, SERIES 200-300

Choose your preferred work surface (painted steel is standard). The full length cabinet features a 500 lb. capacity adjustable center shelf, standard sliding doors and a key lock. No exposed hardware. Caster base is recommended for the 28" high to ensure proper height work surface.

12
GAUGE
STEEL



* Add "SS" to any WTL part number for *Stainless Steel Tops*

PART #	W x D x H
WTL200	48" x 28" x 28"
WTL202	60" x 28" x 28"
WTL204	72" x 28" x 28"
WTL300	48" x 28" x 34"
WTL302	60" x 28" x 34"
WTL304	72" x 28" x 34"

- No exposed hardware
- Heavy-duty steel legs and work surface
- Optional work surfaces available
- Available in widths of 48", 60" and 72"
- Full-length enclosed under bench cabinet
- Adjustable center shelf holds up to 500 lbs
- Sliding doors with key lock standard
- Full-length top and bottom door tracks

200 SERIES*:

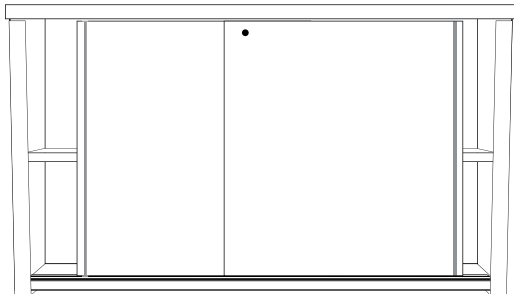

300 SERIES:

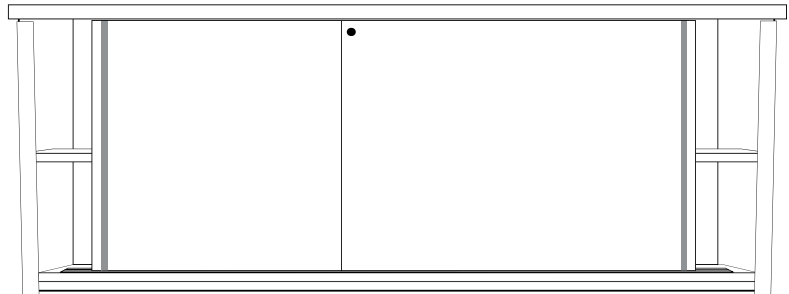

WTL BENCHES, SERIES 350

The 350 Series has all the features of the 200 and 300 series. The 350 Series has an elevated bottom shelf and shorter doors (28") for cleaning underneath the bench.

PART #	W x D x H
WTL350	48" x 28" x 34"
WTL352	60" x 28" x 34"
WTL354	72" x 28" x 34"

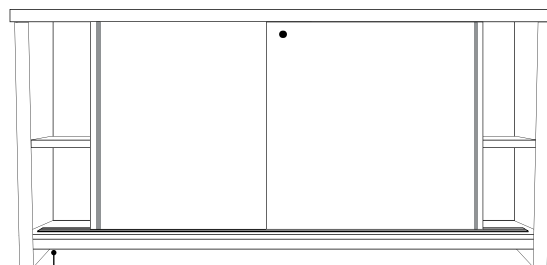

Elevated bottom provides easier cleaning underneath bench.

CASTER BASE

- 11 gauge welded steel tube construction.
- Sturdy, wide-profile casters rated for 600 lb. capacity.



11
GAUGE
STEEL

PART #	WIDTH
11147-000	48"
11147-001	60"
11147-002	72"

SPECIALTY BENCHES

ENCLOSED TECH BENCH, SERIES 300

Available with painted or stainless steel top. The full length cabinet features a 500 lb. capacity adjustable center shelf. Doors must be ordered separately.



12 GAUGE STEEL

PART #	W x D x H
WCL300	48" x 28" x 34"
WCL302	60" x 28" x 34"
WCL304	72" x 28" x 34"

LOCKING SLIDING DOOR KIT SERIES 300



12 GAUGE STEEL

PART #	WIDTH
WSDL300	48"
WSDL302	60"
WSDL304	72"

SHOP FURNITURE

COUNTER UNIT WITH STAINLESS STEEL TOP

Our Quicklane counter is designed for efficiently storing fast moving small or medium-size parts, and is great for retail and tech counters. The lower shelf is ideal for storing fluids and bulky items.



PART #	W x D x H
HDC8424	84" x 25" x 39"
HDC7224	72" x 25" x 39"

TRANSMISSION TEAR-DOWN BENCH

The 48" x 28" angled top, with plastic catch bin, keeps transmission and engine repair messes contained. The bin removes easily for dumping fluid. Adjustable leg height. Two rigid and two locking casters.

PART #	Descriptions
11106-001	stainless steel top
11106-000	painted steel top



Shown with optional Tier Drawer (page 109)



Scan this QR Code to download **Transmission Tear-Down Bench** assembly instructions.

RACK STORAGE



TIRE RACKS

Borroughs Tire Racks are made of Rivet-Span construction, and require no nuts or bolts for assembly. Tires rest on angle beam, keeping them securely in place. Available in single or double-entry units.

PART #	Unit Width	Unit Depth	Unit Height	Tire Levels	Tire Capacity
B60SETB37	60"	12"	7' 84"	3	15
B60SETB40	60"	12"	10' 120"	4	20
B60SETB52	60"	12"	12' 144"	5	25
B60DETB37	60"	42"	7' 84"	3	30
B60DETB40	60"	42"	10' 120"	4	40
B60DETB52	60"	42"	12' 144"	5	50



BATTERY RACKS

Borroughs gravity-fed Battery Racks offer four levels of battery storage on angled mesh decking, with no rollers to break or seize. A corrosion resistant coating ensures longevity.

PART #	Unit Capacity	Unit Width	Unit Depth	List Height
6036604S (Starter)	100	60"	36"	60"
6036604A (Adder)	100	60"	36"	60"
60059-000-000	Battery Drip Pan		36" x 60"	

Note: Wire decking is galvanized.



BUMPER RACKS

Borroughs Bumper Racks save floor space by storing bumpers and bumper covers vertically. Elevated arms with 24" depth adjust in 1" vertical increments. Anti-tip angle iron base can be easily anchored to the floor for extra stability.

PART #	W x D x H	Levels	Sides
BCRS4-844836	48"W x 36"D x 84"H	4	Single Sided
BCRD4-844860	48"W x 60"D x 84"H	4	Double Sided
BCRS5-964836	48"W x 36"D x 96"H	5	Single Sided
BCRD5-964860	48"W x 60"D x 96"H	5	Double Sided
BCA24-2			Extra Level (2 Arms)

AUTOMOTIVE WORKSTATIONS

We manufacture the industry's strongest tool drawers with a quiet self-close feature. We designed our upper cabinets to use minimal effort to open, with a standard soft close mechanism. We even researched placement of storage, to reduce your technician's footsteps and speed up service. The final result – A Borroughs workstation that runs smoothly and efficiently.

- Drawers feature best slides in the industry with 110% drawer extension. This allows for technicians to quickly locate tools or hardware in the back of the drawers.
- Upper cabinets are intentionally designed so technicians can lift the door with one hand– without torquing or twisting. This allows for faster retrieval of supplies, manuals or stowed away items.
- All locks boast a removable core to easily change if necessary, and can be keyed alike or individually, for your security needs.
- Lift control and reel cabinets feature knock-out back and bottom panels for easy installation of utilities, and integrate seamlessly into the workstations.
- Clean, well designed workstations help brand your business, increases customer return rate, and increases productivity and technician retention rates.
- Under counter lights feature magnetic bases and easy plug-in chaining for customized applications.
- Interlocking component design combined with hidden fasteners and superior cable management create a clean, professional appearance.



Double Tech Automotive Workstation with Upper Cabinets with Computer Monitor Cabinet, Tool Storage Cabinets, Lift Control Pump Cabinets, Trash/Cart Garage, and a Tapered Stainless Steel Work Surface.

EXAMPLE CONFIGURATIONS

MORE INFORMATION

For more information and a complete list of Borroughs' Automotive workstation offerings, please contact your local Borroughs Dealer, a Borroughs Regional Manager or visit www.borroughs.com and download an Automotive Workstation brochure.



Pictured Left: Quick Lane Oil Change workstations were configured by dealer Arkansas Auto Equipment's for their end user's dealership.

Above: Rotterdam Mohanasen Central School District's Transportation Department worked with dealer Innerspace Systems, Inc. to configure their units for their new facility.

Below: Team Mancuso Powersports configured several units to service their brand new facility in Houston, Texas.



MODU-BENCHES



420 SERIES

PART #	W x D x H	Notes
MB420	48" x 28" x 34"	with base
MB421	60" x 28" x 34"	with base
MB422	72" x 28" x 34"	with base
MB426	48" x 28" x 30 ^{3/4} "	no base
MB427	60" x 28" x 30 ^{3/4} "	no base
MB428	72" x 28" x 30 ^{3/4} "	no base



430 SERIES

PART #	W x D x H	Notes
MB431	60" x 28" x 34"	with base
MB432	72" x 28" x 34"	with base



440 SERIES

PART #	W x D x H	Notes
MB441	60" x 28" x 34"	with base
MB442	72" x 28" x 34"	with base

GROOVED KEY LOCK

Designed specifically for Tier Drawers and Modu-Bench Cabinets. Install simply and easily at any time. Each lock can be keyed differently. Master keys are available.



PART #
06594-00



The Borroughs Modu-bench series gives great functionality for maintenance areas, and tool rooms. Great work surfaces combined with lockable and accessible drawers provide an organized work station for techs and machinists to complete tasks.

MODU-BENCH COMPONENTS & ACCESSORIES

MODU-DRAWER UNIT

Provides four large drawers. Each drawer can be used with an optional grooved key lock or padlock hasp. Rollers and guides assure years of smooth operation. Units with steel tops require a Tier Drawer Support.

Shown with optional base ("B" in part number = Base).



PART #	W x D x H
MDU15	15 ¹ / ₄ " x 20" x 29"
MDU21	21 ¹ / ₄ " x 20" x 29"
MDUB15	15 ¹ / ₄ " x 20" x 32 ¹ / ₄ "
MDUB21	21 ¹ / ₄ " x 20" x 32 ¹ / ₄ "

TIER DRAWER BASE

Flanged at top and bottom, with dimples matching the drawers for easy stacking. Adds 3 1/4" to bench height. Use 15 1/4" width base for Modu-Bench Cabinets. Two sizes available.



PART #	W x D x H
14887-000	15 ¹ / ₄ " x 20" x 31 ¹ / ₄ "
14887-001	21 ¹ / ₄ " x 20" x 31 ¹ / ₄ "

MODU-BENCH CABINET

Can be positioned with either end up for left-or-right-hand opening. Door comes with recessed handle and knock-out for optional grooved key lock. One shelf included, adjustable in three positions. Units with steel tops require a Tier Drawer Support.

Shown with optional base, page 103



PART #	W x D x H
00290-056	15 ¹ / ₄ " x 20" x 29"

TIER DRAWERS

Used with work benches, modu-benches or transmission tear-down benches. Can be mounted individually beneath the bench, side-by-side, or hanging in tiers. Drawers slide easily on steel rollers and guides. Units with steel tops require a Tier Drawer Support.



PART #	W x D x H
14865-000	15 ¹ / ₄ " x 20" x 7 ¹ / ₄ "
14865-001	21 ¹ / ₄ " x 20" x 7 ¹ / ₄ "

TIER DRAWER/HANGING PEDESTAL SUPPORTS

Attach to underside of steel tops for support of tier drawers and hanging drawer pedestals. Allows positioning of drawer anywhere along underside of top. Sold in pairs.



PART #	WIDTH
14823-000	28"
14823-001	34"

TIER DRAWER TRAY

Holds small tools, parts and instruments conveniently away from main contents of drawer. Rests on flanges on the tier drawer.



PART #	DEPTH
14880-000	15 ¹ / ₄ "
14880-001	21 ¹ / ₄ "

HANGING DRAWER PEDESTAL

Used with work benches and modu-benches. Drawers slide easily on steel rollers and guides. Units with steel tops require a Tier Drawer Support. Requires additional lead time. Includes plunger lock.



PART #	W x D x H
HDP2	15 ¹ / ₄ " x 21" x 19 ¹ / ₄ "



RTA CABINETS

STORAGE CABINET

Borroughs Storage Cabinets are built for functionality and longevity. Reinforced doors, bullet hinges, 4" riser base, 3-point locking system and satin chrome handles are standard. Shelves (4) adjust on 1.5" increments. 4" caster bases optional.



PART #	W x D x H
10870-000	36" x 18" x 78"
10870-001	36" x 24" x 78"
10870-004	36" x 18" x 72"
10480-010	36" x 24" x 72"



- Doors lock with keyed entry.
- Locking bars secure doors at top and bottom to prevent rattling.
- Shelves slide into slots formed in the back of the cabinet and rest on shelf clips for easy configuration.

EXTRA SHELVES



PART #	W x D
10857-002	36" x 18"
10857-001	36" x 24"
10857-004	48" x 24"

COAT ROD KIT

Borroughs full width aluminum coat rod kits provide hanging storage for 36" wide openings. Each kit comes with rod, brackets and hardware.



PART #	W x D
10899-008	36" x 18"
10899-010	36" x 24"

COUNTER-HEIGHT CABINET

Borroughs Counter-Height Cabinets can double as a work surface or be stowed neatly under a counter or table. Reinforced doors, bullet hinges, 4" riser base, 3-point locking system and satin chrome handles are standard. Shelf (1) adjust on 1.5" increments (4" caster bases as shown is optional).



PART #	W x D x H
10842-000	36" x 18" x 42"

CASTER BASE

Move any storage cabinet easily with optional welded frame steel caster bases. Rubber casters add 4" to cabinet height. 600 lb. load capacity.



PART #	W x D
10899-058	36" x 18"
10899-059	36" x 24"



Scan this QR Code to download **RTA Cabinet** installation instructions.

RTA CABINETS



GARMENT CABINET

Borroughs Garment Cabinets are designed for garment storage. Reinforced doors, bullet hinges, 4" riser base, 3-point locking system and satin chrome handles are standard. 4" caster bases optional. Shelves adjust on 1.5" increments. 1" dia. aluminum coat rod comes standard.

PART #	W x D x H
10870-003	36" x 18" x 78"



XL CABINET

Borroughs XL Cabinets are designed for additional space. Reinforced hinged doors, bullet hinges, 4" riser base, 3-point locking system and levelers are standard. Shelves (4) adjust on 1.5" increments.

PART #	W x D x H
JSD2478SU	48" x 24" x 78"

COMBO STORAGE CABINET

Borroughs Combo Storage Cabinets combine garment and multi-purpose storage. Reinforced doors, bullet hinges, 4" riser base, 3-point locking system and satin chrome handles are standard. Includes (1) full-width and (4) half-width shelves. 4" caster bases optional. Shelves adjust on 1.5" increments.

PART #	W x D x H
10870-002	36" x 18" x 78"



COMBINATION CABINETS



45" COMBINATION CABINETS (FORKLIFT BASE STANDARD)

- Progressive operation provides for the smoothest operating drawers in the industry.
- 400 lb. capacity w/ 110% full extension for full access to back of drawer.
- Auto-safety clips lock the suspension to the drawer, preventing accidental release.
- All drawers are supplied with a black, non-slip liner.
- Multiple drawer access standard.
- Locks are keyed-alike.
- Change "FT" in the part number to "SL" for stainless steel legs.

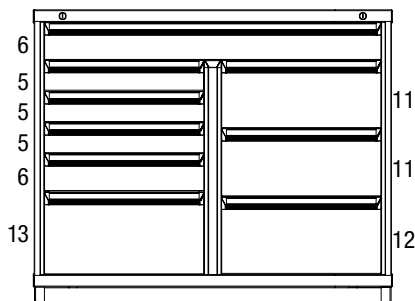

A1-C452940FT-MD09AM

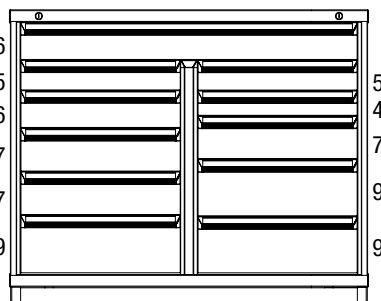

A1-C452940FT-MD11AM

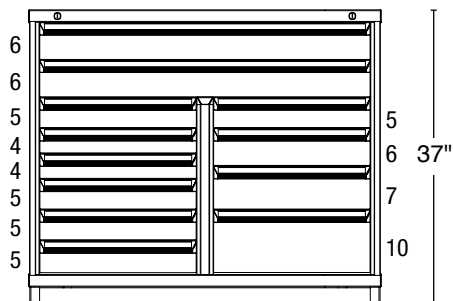

A1-C452940FT-MD12AM

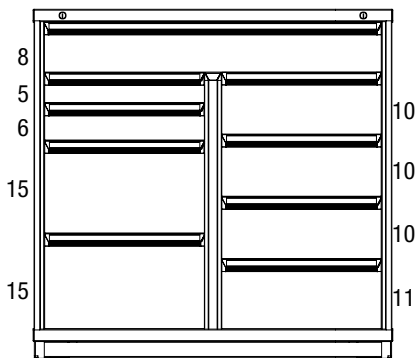

A1-C452949FT-MD09AM

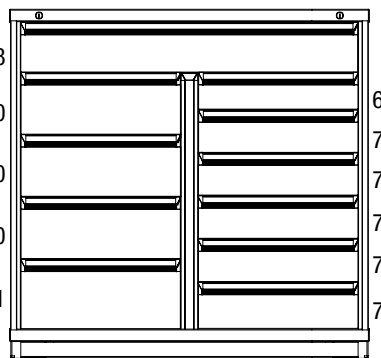

A1-C452949FT-MD11AM

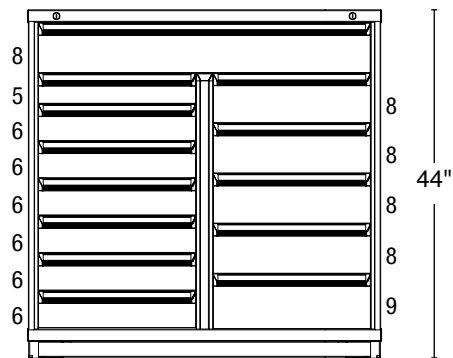

A1-C452949FT-MD13AM

Drawer Table	Drawer Number	4	5	6	7	8	9	10	11	12	13	14	15	16	17	18
	Drawer Front	3 ¹ / ₁₆ "	3 ⁷ / ₈ "	4 ⁵ / ₈ "	5 ⁷ / ₁₆ "	6 ³ / ₁₆ "	7"	7 ³ / ₄ "	8 ⁹ / ₁₆ "	9 ³ / ₈ "	10 ¹ / ₈ "	10 ¹⁵ / ₁₆ "	11 ³ / ₄ "	12 ¹ / ₂ "	13 ⁵ / ₁₆ "	14 ¹ / ₁₆ "
	Usable Height	2 ¹ / ₄ "	3 ¹ / ₁₆ "	3 ⁷ / ₈ "	4 ⁵ / ₈ "	5 ⁷ / ₁₆ "	6 ¹ / ₄ "	7"	7 ³ / ₄ "	8 ⁹ / ₁₆ "	9 ³ / ₈ "	10 ¹ / ₈ "	10 ¹⁵ / ₁₆ "	11 ³ / ₄ "	12 ¹ / ₂ "	13 ⁵ / ₁₆ "

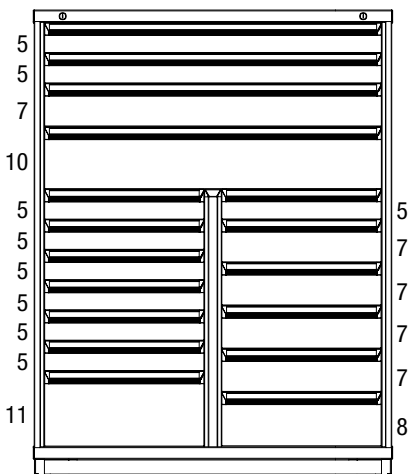

A1-C452968FT-MD17AM

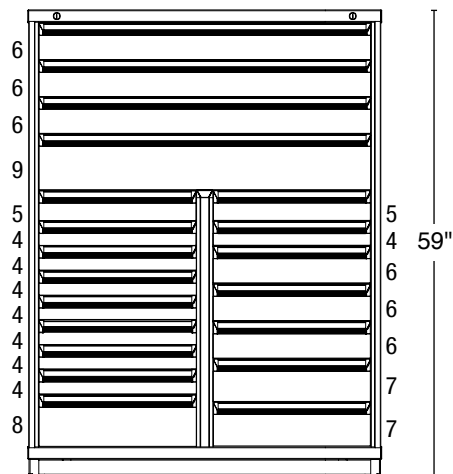

A1-C452968FT-MD20AM



Need help with your order? Our Customer Service Dept. is available Monday-Friday, 8am - 5pm (ET).
Call 1-800-748-0227 x 4801.

COMBINATION CABINETS



60" WIDE COMBINATION CABINETS (FORKLIFT BASE STANDARD)

- Progressive operation provides for the smoothest operating drawers in the industry.
- 400 lb. capacity w/ 110% full extension for full access to back of drawer.
- Auto-safety clips lock the suspension to the drawer, preventing accidental release.
- All drawers are supplied with a black, non-slip liner.
- Multiple drawer access standard.
- Locks are keyed-alike.
- Change "FT" in the part number to "SL" for stainless steel legs.

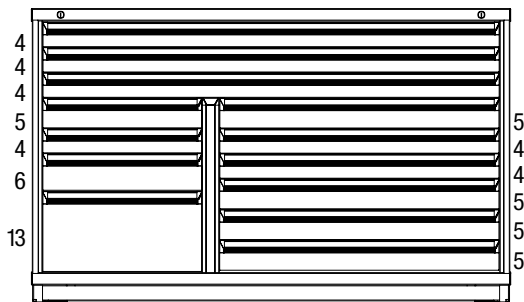

A1-C602940FT-MD13AM

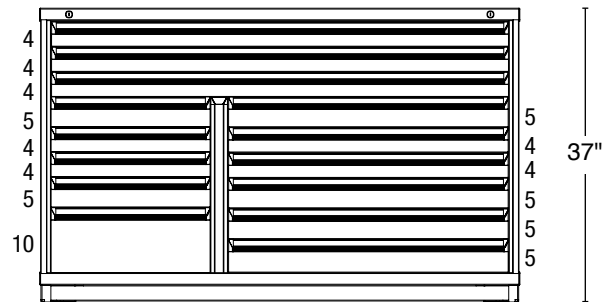

A1-C602940FT-MD14AM

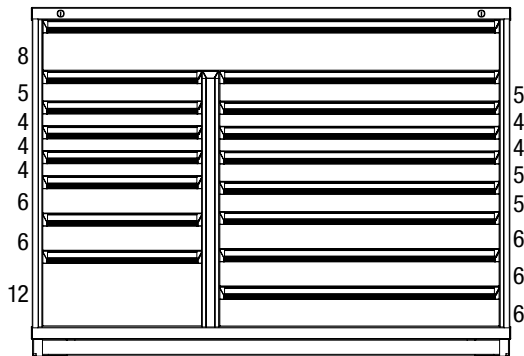

A1-C602949FT-MD16BM

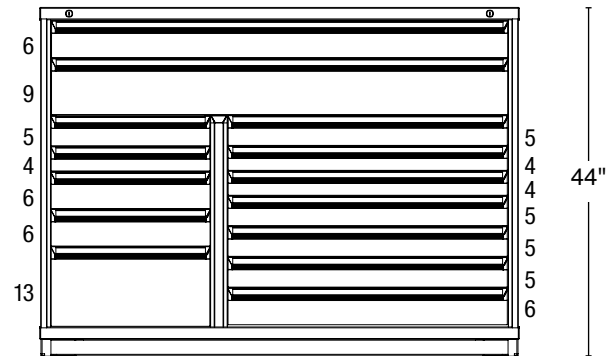

A1-C602949FT-MD14AM

Drawer Table	Drawer Number	4	5	6	7	8	9	10	11	12	13	14	15	16	17	18
	Drawer Front	3 ¹ / ₁₆ "	3 ⁷ / ₈ "	4 ⁵ / ₈ "	5 ⁷ / ₁₆ "	6 ³ / ₁₆ "	7"	7 ³ / ₄ "	8 ⁹ / ₁₆ "	9 ³ / ₈ "	10 ¹ / ₈ "	10 ¹⁵ / ₁₆ "	11 ³ / ₄ "	12 ¹ / ₂ "	13 ⁵ / ₁₆ "	14 ¹ / ₁₆ "
	Usable Height	2 ¹ / ₄ "	3 ¹ / ₁₆ "	3 ⁷ / ₈ "	4 ⁵ / ₈ "	5 ⁷ / ₁₆ "	6 ¹ / ₄ "	7"	7 ³ / ₄ "	8 ⁹ / ₁₆ "	9 ³ / ₈ "	10 ¹ / ₈ "	10 ¹⁵ / ₁₆ "	11 ³ / ₄ "	12 ¹ / ₂ "	13 ⁵ / ₁₆ "

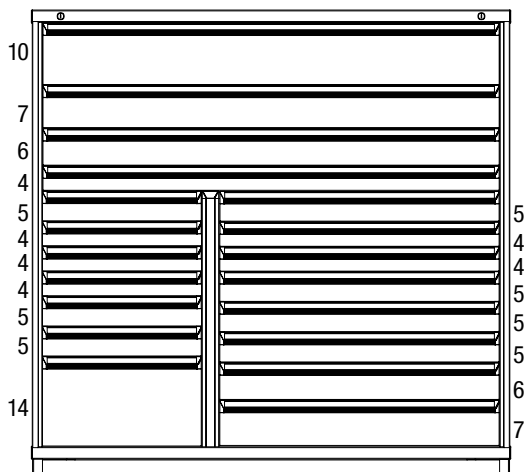

A1-C602968FT-MD19BM

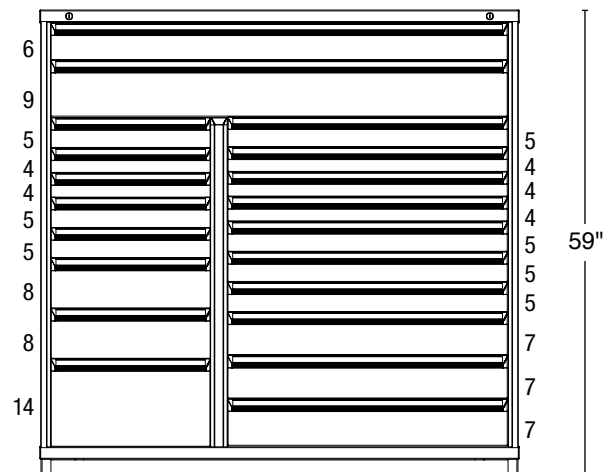

A1-C602968FT-MD20CM

MOBILE COMBINATION CABINETS

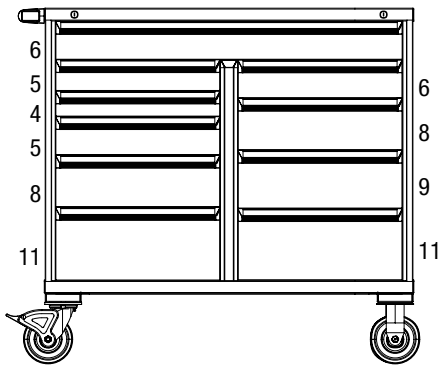

A1-C452940M6-SD10AM

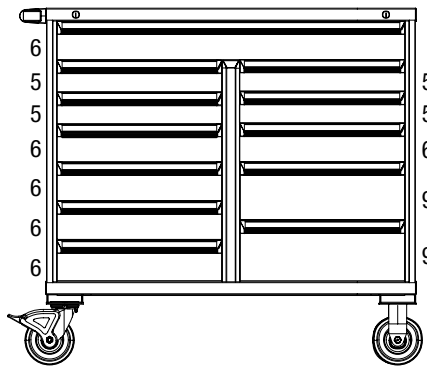

A1-C452940M6-SD12BM

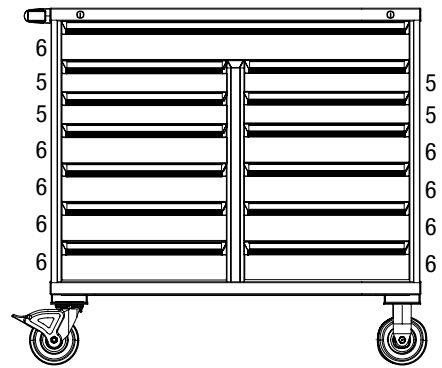

A1-C452940M6-SD13AM

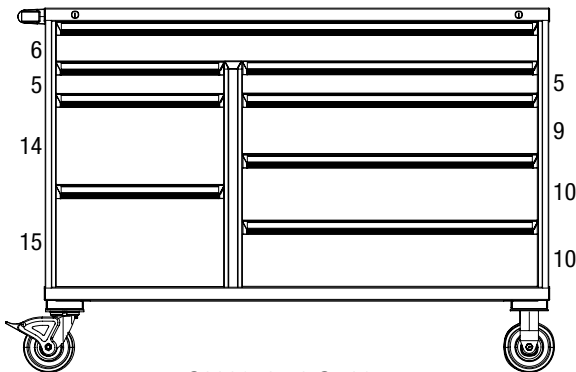

A1-C602940M6-SD08AM

Single drawer access on top & right side drawers only. Multiple drawer access on left side drawers.

See features page 115

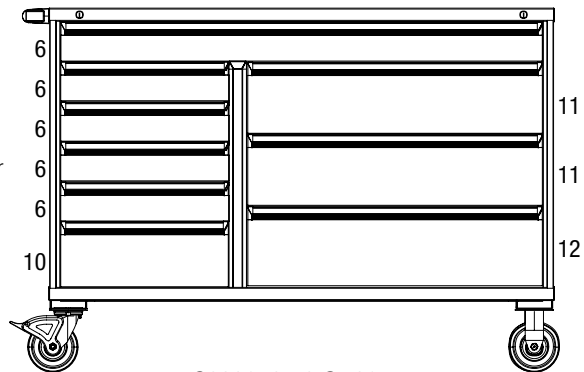

A1-C602940M6-SD09BM

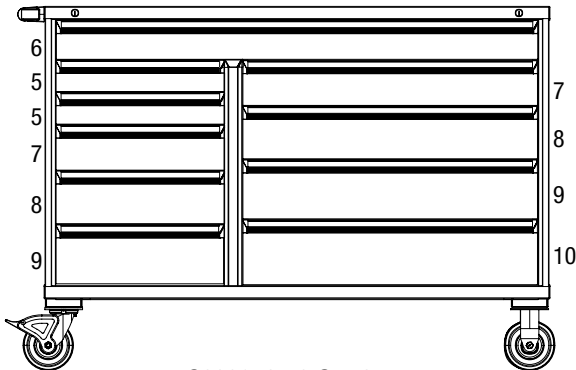

A1-C602940M6-SD10AM

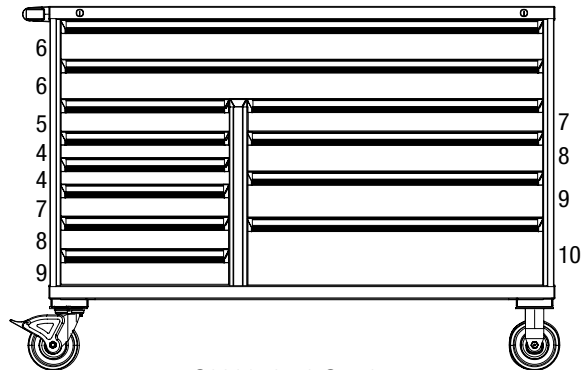

A1-C602940M6-SD12BM

Drawer Number	4	5	6	7	8	9	10	11	12	13	14	15	16	17	18
Drawer Front	3 ¹ / ₁₆ "	3 ⁷ / ₈ "	4 ⁵ / ₈ "	5 ⁷ / ₁₆ "	6 ³ / ₁₆ "	7"	7 ³ / ₄ "	8 ⁹ / ₁₆ "	9 ³ / ₈ "	10 ¹ / ₈ "	10 ¹⁵ / ₁₆ "	11 ³ / ₄ "	12 ¹ / ₂ "	13 ⁵ / ₁₆ "	14 ¹ / ₁₆ "
Usable Height	2 ¹ / ₄ "	3 ¹ / ₁₆ "	3 ⁷ / ₈ "	4 ⁵ / ₈ "	5 ⁷ / ₁₆ "	6 ¹ / ₄ "	7"	7 ³ / ₄ "	8 ⁹ / ₁₆ "	9 ³ / ₈ "	10 ¹ / ₈ "	10 ¹⁵ / ₁₆ "	11 ³ / ₄ "	12 ¹ / ₂ "	13 ⁵ / ₁₆ "

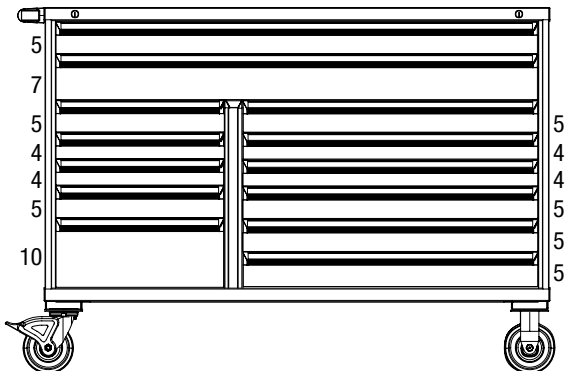

A1-C602940M6-SD13BM

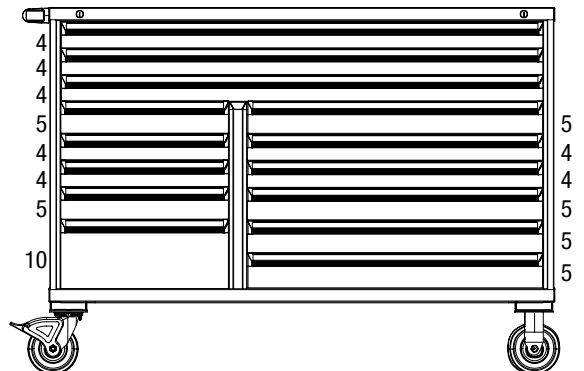

A1-C602940M6-SD14AM

SIDE-BY-SIDE MOBILE CABINETS



- Stainless steel tops and push/pull handle standard (only on side-by-sides).
- (2) locking swivel & (2) straight 6" casters.
- Progressive operation provides for the smoothest operating drawers in the industry.
- 400 lb. capacity w/ 110% full extension for full access to back of drawer.
- Auto-safety clips lock the suspension to the drawer, preventing accidental release.
- All drawers are supplied with a black, non-slip liner.
- Single drawer access standard.
- Locks are keyed-alike.

41" height cabinets

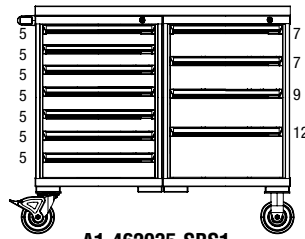

A1-462935-SBS1

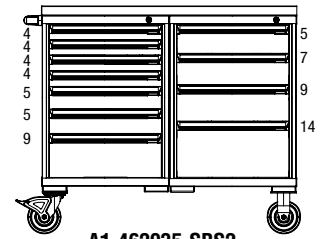

A1-462935-SBS2

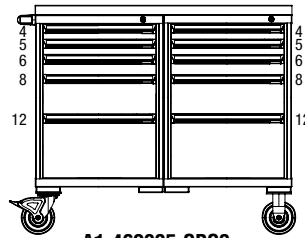

A1-462935-SBS3



A1-462935-SBS4

45" height cabinets

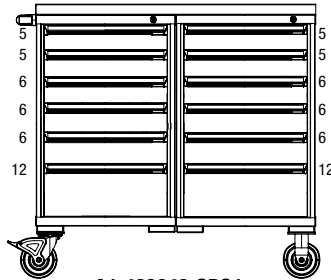

A1-462940-SBS1

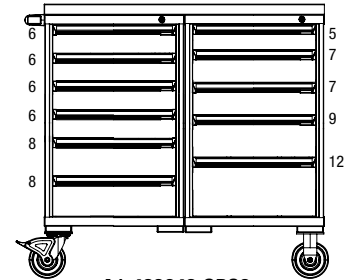

A1-462940-SBS2

Drawer Number	4	5	6	7	8	9	10	11	12	13	14	15	16	17	18
Drawer Front	3 ¹ / ₁₆ "	3 ⁷ / ₈ "	4 ⁵ / ₈ "	5 ⁷ / ₁₆ "	6 ³ / ₁₆ "	7"	7 ³ / ₄ "	8 ⁹ / ₁₆ "	9 ³ / ₈ "	10 ¹ / ₈ "	10 ¹⁵ / ₁₆ "	11 ³ / ₄ "	12 ¹ / ₂ "	13 ⁵ / ₁₆ "	14 ¹ / ₁₆ "
Usable Height	2 ¹ / ₄ "	3 ¹ / ₁₆ "	3 ⁷ / ₈ "	4 ⁵ / ₈ "	5 ⁷ / ₁₆ "	6 ¹ / ₄ "	7"	7 ³ / ₄ "	8 ⁹ / ₁₆ "	9 ³ / ₈ "	10 ¹ / ₈ "	10 ¹⁵ / ₁₆ "	11 ³ / ₄ "	12 ¹ / ₂ "	13 ⁵ / ₁₆ "



Same features as above, and in addition:

- Shelves feature a 400 lb. capacity.
- Includes (1) bottom shelf and (1) adjustable shelf.
- Unique die-cast pull handle with a 3-point locking system.

41" height cabinets

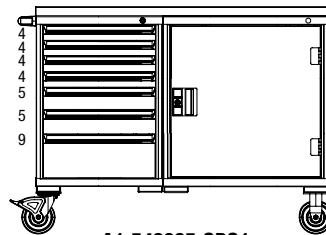

A1-542935-SBS1

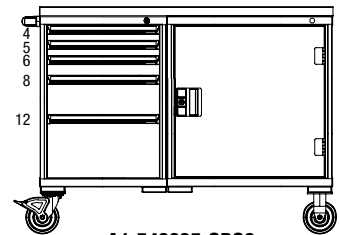

A1-542935-SBS2

45" height cabinets

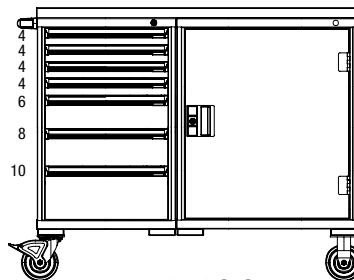

A1-542940-SBS1

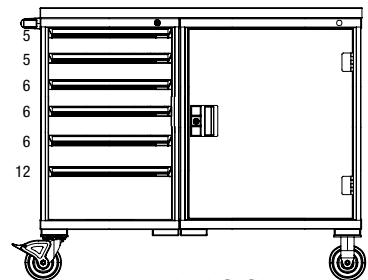

A1-542940-SBS2

UTILITY CARTS



SERVICE CARTS

The Service Cart is a mobile platform for technicians' tools and repair parts. Designed to fit under the work surface and behind a lockable garage, this cart can maneuver right where you need it.

PART #	DESCRIPTION	W x D x H
A1-BSC	Basic Service Cart	22" x 24" x 34"
A1-BSCF	Basic Service Cart with 12" Flipup	22" x 24" x 34"
A1-BSCFH	Basic Service Cart with Flipup and Hardwood	22" x 24" x 34"
A1-BSCD2	Basic Service Cart with two Drawers	
A1-BSCFD2	Basic Service Cart with 12" Flipup Shelf and two Drawers	
A1-BSCHD2	Basic Service Cart with Hardwood Top and two Drawers	
A1-BSCFHD2	Basic Service Cart with 12" Flipup Shelf and Hardwood Top and two Drawers	

1 Drawer units available. Simply change part number on drawer units to reflect a 1 instead of 2 at the end.

- 4 - Swivel casters on non-marking impact resistant treads.
- 2 - 100 lb. capacity fixed (top & bottom) shelves.
- 1 - 100 lb. capacity adjustable (middle) shelf.



INDUSTRIAL GRADE UTILITY CART

Four 5" rubber-tread casters on this rugged cart make the going easy, even in carpeted areas. Each of the two shelves is 3 1/2" deep, with hemmed edges for a smooth finish. The top shelf can be inverted when a flat surface is desired. Convenient push-bar type handle gives full control for steering cart. Swiveled casters at handle end, fixed casters at the other end.

PART #	WIDTH	DEPTH	HEIGHT
00160-043	16"	30"	32"
00240-043	24"	36"	32"



EXTRA SHELVES (FOR INDUSTRIAL GRADE UTILITY CARTS)

Extra shelves are available for additional storage. These shelves can be inverted when a flat surface is desired.

PART #	WIDTH	DEPTH	HEIGHT
06707-000	16"	30"	3 1/2"
06721-000	24"	36"	3 1/2"

B-SPAN®

Wide-span Storage for your Largest, Non-palletized Inventory.

Borroughs B-Span provides a heavy-duty storage solution with an easily accessible, wide-span design. B-Span bridges the gap between clip-type shelving like Box Edge Plus and full-scale pallet racking, and can accommodate many, or most, of the hardest to store hand-loaded products. The small beam face of 3" compared to standard pallet rack at 6" allows for more vertical space maximization. The carefully designed beam and post are aesthetically pleasing and are offered in 7 standard colors, making it suitable for not only warehouses, but show rooms, and service areas too. B-Span is the primary system used in our heavy-duty specialty racks, such as battery racks. Accessories such as back-to-back ties, wall ties and foot plates add strength and stability. The B-Span keystone B-post design uses roll-formed posts as high as 19' with keystone slots shared by beams to create a run. B-Span flush beams support either wire decking or corrugated flat steel.



(01)



(02)



(03)



(04)



(05)



(06)



(07)



SHELVING



- Allows for beam adjustments on 2" centers
- Recessed tail flange keeps hardware from encroaching into storage space (bolt together)
- Posts are punched to accommodate Borroughs Box Edge Plus Shelves

POSTS

Height	Bulk Rack Post PART #	Weight
48"	60000-000	8.4
60"	60000-001	10.4
72"	60000-002	12.5
84"	60000-003	14.6
96"	60000-004	16.7
120"	60000-005	20.8
144"	60000-006	25.0

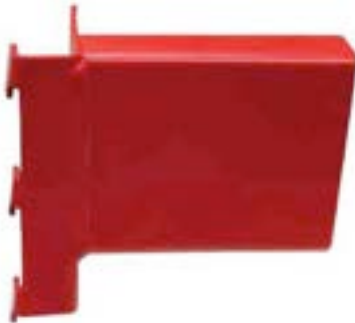

- Beams are designed with two gauge choices: 14 gauge (standard duty) or 12 gauge (heavy duty)
- Beams are available in 4, 5, 6, 7, 8, 9, & 10ft. widths, adjustable on 2" centers
- Beam steps are 9/16" or 3/4" to accommodate various decking options
- Beams can be placed at any level regardless of bracing or splices
- Deck over beams can be utilized as part of a full mat system
- Flush bottom beams are available for Aisle-Saver® mobile integration



BEAMS

14 g. 3/4" Step	Beam PART #	Weight
48"	60006-001	8.3
60"	60006-002	10.0
72"	60006-003	11.9
84"	60006-004	16.7
96"	60006-005	15.5
108"	60006-006	17.3
120"	60006-007	19.1

14 g. 9/16" Step	Beam PART #	Weight
48"	60006-008	8.3
60"	60006-009	10.0
72"	60006-010	11.9
84"	60006-011	16.7
96"	60006-012	15.5
108"	60006-013	17.3
120"	60006-014	19.1

12 g. 3/4" Step	Beam PART #	Weight
48"	60006-015	10.9
60"	60006-016	13.4
72"	60006-017	15.8
84"	60006-018	18.3
96"	60006-019	20.8
108"	60006-020	23.3
120"	60006-021	25.8

12 g. 9/16" Step	Beam PART #	Weight
48"	60006-022	10.9
60"	60006-023	13.4
72"	60006-024	15.8
84"	60006-025	18.3
96"	60006-026	20.8
108"	60006-027	23.3
120"	60006-028	25.8

CLIP

- Provides a solid connection between posts and beams. B-Clips come standard with a passive safety clip.

SHELVING

FRAMES

D x H	Welded PART #	Weight	To-Assemble PART #	Weight
12x48	60002-001	19.5	60007-001	19.5
12x60	60002-002	23.5	60007-002	23.5
12x72	60002-003	27.7	60007-003	27.7
12x84	60002-004	31.9	60007-004	31.9
12x96	60002-005	38.1	60007-005	38.1
15x48	60002-008	19.8	60007-008	19.8
15x60	60002-009	23.8	60007-009	23.8
15x72	60002-010	28.0	60007-010	28.0
15x84	60002-011	32.2	60007-011	32.2
15x96	60002-012	38.6	60007-012	38.6
18x48	60002-015	20.0	60007-015	20.0
18x60	60002-016	24.0	60007-016	24.0
18x72	60002-017	28.4	60007-017	28.4
18x84	60002-018	32.6	60007-018	32.6
18x96	60002-019	39.2	60007-019	39.2
24x48	60002-022	20.8	60007-022	20.8
24x60	60002-023	24.8	60007-023	24.8
24x72	60002-024	31.8	60007-024	31.8
24x84	60002-025	36.0	60007-025	36.0
24x96	60002-026	40.2	60007-026	40.2
24x120	60002-027	51.3	60007-027	51.3
24x144	60002-028	59.7	60007-028	59.7
30x48	60002-029	21.6	60007-029	21.6
30x60	60002-030	25.4	60007-030	25.4
30x72	60002-031	32.4	60007-031	32.4
30x84	60002-032	36.8	60007-032	36.8
30x96	60002-033	41.2	60007-033	41.2
30x120	60002-034	52.4	60007-034	52.4
30x144	60002-035	60.8	60007-035	60.8
36x48	60002-036	22.0	60007-036	22.0
36x60	60002-037	25.8	60007-037	25.8
36x72	60002-038	33.0	60007-038	33.0
36x84	60002-039	37.4	60007-039	37.4
36x96	60002-040	42.0	60007-040	42.0
36x120	60002-041	53.5	60007-041	53.5
36x144	60002-042	61.8	60007-042	61.8
42x48	60002-043	22.4	60007-043	22.4
42x60	60002-044	26.2	60007-044	26.2
42x72	60002-045	33.4	60007-045	33.4
42x84	60002-046	38.0	60007-046	38.0
42x96	60002-047	42.8	60007-047	42.8
42x120	60002-048	54.5	60007-048	54.5
42x144	60002-049	62.8	60007-049	62.8
48x48	60002-050	23.0	60007-050	23.0
48x60	60002-051	27.0	60007-051	27.0
48x72	60002-052	34.4	60007-052	34.4
48x84	60002-053	39.0	60007-053	39.0
48x96	60002-054	44.0	60007-054	44.0
48x120	60002-055	57.0	60007-055	57.0
48x144	60002-056	64.0	60007-056	64.0

- Frames are available as Welded or Ready-to-Assemble (bolt together)
- Frames come in heights from 48"-144" high and depths of 12"-48"
- Frames can be used for both B-Span beams and/or Box Edge Plus shelves



Welded frame shown



Ready-To-Assemble (bolt together) frame shown

SHELVING

DECK OVER AND FLUSH BOTTOM BEAMS

14 g. 3/4" Step	Flush Bottom Beam PART #	Weight	Deck Over Beam PART #	Weight
48"	60006-029	8.3	60006-057	8.3
60"	60006-030	10.0	60006-058	10.0
72"	60006-031	11.9	60006-059	11.9
84"	60006-032	16.7	60006-060	16.7
96"	60006-033	15.5	60006-061	15.5
108"	60006-034	17.3	60006-062	17.3
120"	60006-035	19.1	60006-063	19.1
14 g. 9/16" Step	Flush Bottom Beam PART #	Weight	Deck Over Beam PART #	Weight
48"	60006-036	8.3	60006-064	8.3
60"	60006-037	10.0	60006-065	10.0
72"	60006-038	11.9	60006-066	11.9
84"	60006-039	16.7	60006-067	16.7
96"	60006-040	15.5	60006-068	15.5
108"	60006-041	17.3	60006-069	17.3
120"	60006-042	19.1	60006-070	19.1
12 g. 3/4" Step	Flush Bottom Beam PART #	Weight	Deck Over Beam PART #	Weight
48"	60006-043	10.9	60006-071	10.9
60"	60006-044	13.4	60006-072	13.4
72"	60006-045	15.8	60006-073	15.8
84"	60006-046	18.3	60006-074	18.3
96"	60006-047	20.8	60006-075	20.8
108"	60006-048	23.3	60006-076	23.3
120"	60006-049	25.8	60006-077	25.8
12 g. 9/16" Step	Flush Bottom Beam PART #	Weight	Deck Over Beam PART #	Weight
48"	60006-050	10.9	60006-078	10.9
60"	60006-051	13.4	60006-079	13.4
72"	60006-052	15.8	60006-080	15.8
84"	60006-053	18.3	60006-081	18.3
96"	60006-054	20.8	60006-082	20.8
108"	60006-055	23.3	60006-083	23.3
120"	60006-056	25.8	60006-084	25.8



Flush Bottom Beam



Deck Over Beam





DECKING OPTIONS

DECK OVER AND FLUSH BOTTOM BEAMS

W x D	Corrugated PART #	Flat Steel PART #	Wire PART #
48x12	60008-001	60021-001	60022-001
48x15	60008-002	60021-002	60022-002
48x18	60008-003	60021-003	60022-003
48x24	60008-004	60021-004	60022-004
48x30	60008-005	60021-005	60022-005
48x36	60008-006	60021-006	60022-006
48x42	60008-007	60021-007	60022-007
48x48	60008-008	60021-008	60022-008
60x12	60008-009	60021-009	60022-009
60x15	60008-010	60021-010	60022-010
60x18	60008-011	60021-011	60022-011
60x24	60008-012	60021-012	60022-012
60x30	60008-013	60021-013	60022-013
60x36	60008-014	60021-014	60022-014
60x42	60008-015	60021-015	60022-015
60x48	60008-016	60021-016	60022-016
72x12	60008-017	60021-017	60022-017
72x15	60008-018	60021-018	60022-018
72x18	60008-019	60021-019	60022-019
72x24	60008-020	60021-020	60022-020
72x30	60008-021	60021-021	60022-021
72x36	60008-022	60021-022	60022-022
72x42	60008-023	60021-023	60022-023
72x48	60008-024	60021-024	60022-024
84x12	60008-025	60021-025	60022-025
84x15	60008-026	60021-026	60022-026
84x18	60008-027	60021-027	60022-027
84x24	60008-028	60021-028	60022-028
84x30	60008-029	60021-029	60022-029
84x36	60008-030	60021-030	60022-030
84x42	60008-031	60021-031	60022-031
84x48	60008-032	60021-032	60022-032
96x12	60008-033	60021-033	60022-033
96x15	60008-034	60021-034	60022-034
96x18	60008-035	60021-035	60022-035
96x24	60008-036	60021-036	60022-036
96x30	60008-037	60021-037	60022-037
96x36	60008-038	60021-038	60022-038
96x42	60008-039	60021-039	60022-039
96x48	60008-040	60021-040	60022-040
108x12	60008-041	60021-041	60022-041
108x15	60008-042	60021-042	60022-042
108x18	60008-043	60021-043	60022-043
108x24	60008-044	60021-044	60022-044
108x30	60008-045	60021-045	60022-045
108x36	60008-046	60021-046	60022-046
108x42	60008-047	60021-047	60022-047
108x48	60008-048	60021-048	60022-048
120x12	60008-049	60021-049	60022-049
120x15	60008-050	60021-050	60022-050
120x18	60008-051	60021-051	60022-051
120x24	60008-052	60021-052	60022-052
120x30	60008-053	60021-053	60022-053
120x36	60008-054	60021-054	60022-054
120x42	60008-055	60021-055	60022-055
120x48	60008-056	60021-056	60022-056

CAPACITIES

D x W	Standard Duty 14 g. (lbs)	Heavy Duty 12 g. (lbs)
18x48	1,400	3,000
18x60	1,200	2,600
18x72	1,000	2,200
18x84	900	2,000
18x96	800	1,800
18x108	700	1,600
18x120	600	1,500
24x48	1,400	3,000
24x60	1,200	2,600
24x72	1,000	2,200
24x84	900	2,000
24x96	800	1,800
24x108	700	1,600
24x120	600	1,500
30x48	1,400	3,000
30x60	1,200	2,600
30x72	1,000	2,200
30x84	900	2,000
30x96	800	1,800
30x108	700	1,600
30x120	600	1,500
36x48	1,400	3,000
36x60	1,200	2,600
36x72	1,000	2,200
36x84	900	2,000
36x96	800	1,800
36x108	700	1,600
36x120	600	1,500
48x48	1,200	3,000
48x60	1,000	2,400
48x72	900	2,000
48x84	800	1,800
48x96	700	1,500
48x108	600	1,200
48x120	500	1,000

ACCESSORIES

ACCESSORIES

Depth	Tie Support $\frac{3}{16}$ " step PART #	Weight
12"	60016-000	1.3
15"	60016-001	1.6
18"	60016-002	1.9
24"	60016-003	2.5
30"	60016-004	2.6
36"	60016-005	3.9
42"	60016-006	4.6
48"	60016-007	5.2
Depth	Tie Support $\frac{3}{4}$ " Step PART #	Weight
12"	60016-008	1.3
15"	60016-009	1.6
18"	60016-010	1.9
24"	60016-012	2.5
30"	60016-013	2.6
36"	60016-014	3.9
42"	60016-015	4.6
48"	60016-016	5.2
Depth	Back To Back Tie PART #	Weight
3"	60005-008	10.2
6"	60005-010	11.2
18"	60005-042	13.2
Depth	Wall Tie PART #	Weight
3"	60005-012	10.2
9"	60005-041	
Depth	Shimplate PART #	Weight
3"	60054-080	0.7
Depth	Footplate PART #	Weight
–	60005-005	0.7
Depth	Post Splice PART #	Weight
–	60054-062	1.5



Back to Back Tie



Wall Tie



Foot Plate

BORROUGHS OFFERS FOUR STANDARD DECKING OPTIONS:

- 22 gauge galvanized corrugated steel
- 22 gauge galvanized corrugated steel decking with flat steel top (shown below)
- Waterfall & flat wire decking (waterfall shown below right).



Splicer

BRACING PATTERNS FOR UPRIGHTS/FRAMES

If individual posts and braces are required please see the Borroughs Industrial price book, or contact your Borroughs representative. Below are examples of proper bracing patterns.

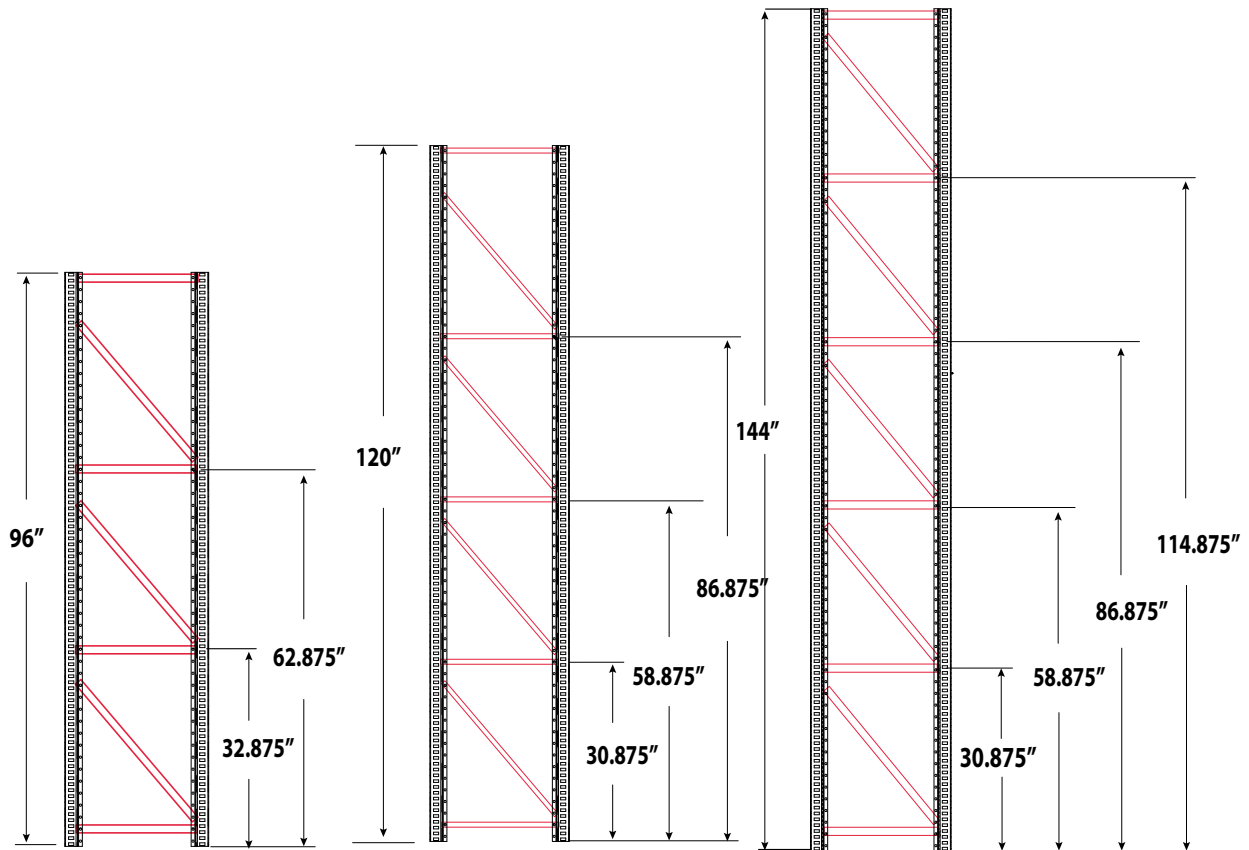
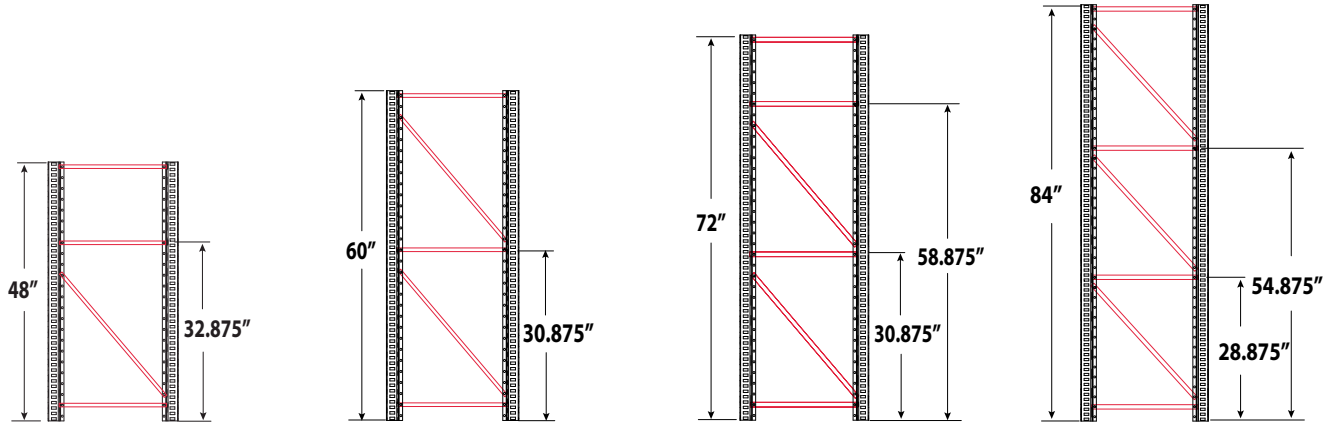

AISLE-SAVER® **High-Density Mobile Storage Systems.**

Aisle-Saver is a high-density storage solution, with a flexible design, that can be configured to meet the exact needs of any manufacturing, retail, or industrial operation or facility. By installing an Aisle-Saver mobile storage system and mobilizing your existing shelving, Aisle-Saver can increase your storage capacity by 50%. The shelves or cabinets are mounted onto carriages and rails, that eliminate the unused aisles, opening only one, for access, as needed. The entire system is compacted, reducing your storage footprint. It's available in an easy-to-move mechanical assist design. By optimizing existing space with Aisle-Saver, you may not need to expand your facility, saving time and money. Aisle-Saver high density storage can be configured using a number of Borroughs industrial products, including heavy duty B-Span, Box Edge Plus industrial shelving, modular drawer cabinets, weapons cabinets, and Rivet-Span. Aisle-Saver mobile storage is low maintenance, and a reliable solution for years to come.



- (01)
- (02)
- (03)
- (04)
- (05)
- (06)
- (07)

Borroughs Mechanical Aisle-Saver® combines precision engineering and intelligent design to make space by saving space.

MECHANICAL ASSIST SYSTEMS

THE MECHANICAL ASSIST SYSTEM'S

Aisle-Saver's powerful 6:1 drive ratio is capable of moving 6,000 lbs. with just 1lb. of pressure. Systems are offered with safety lock and an optional mechanical safety brake.

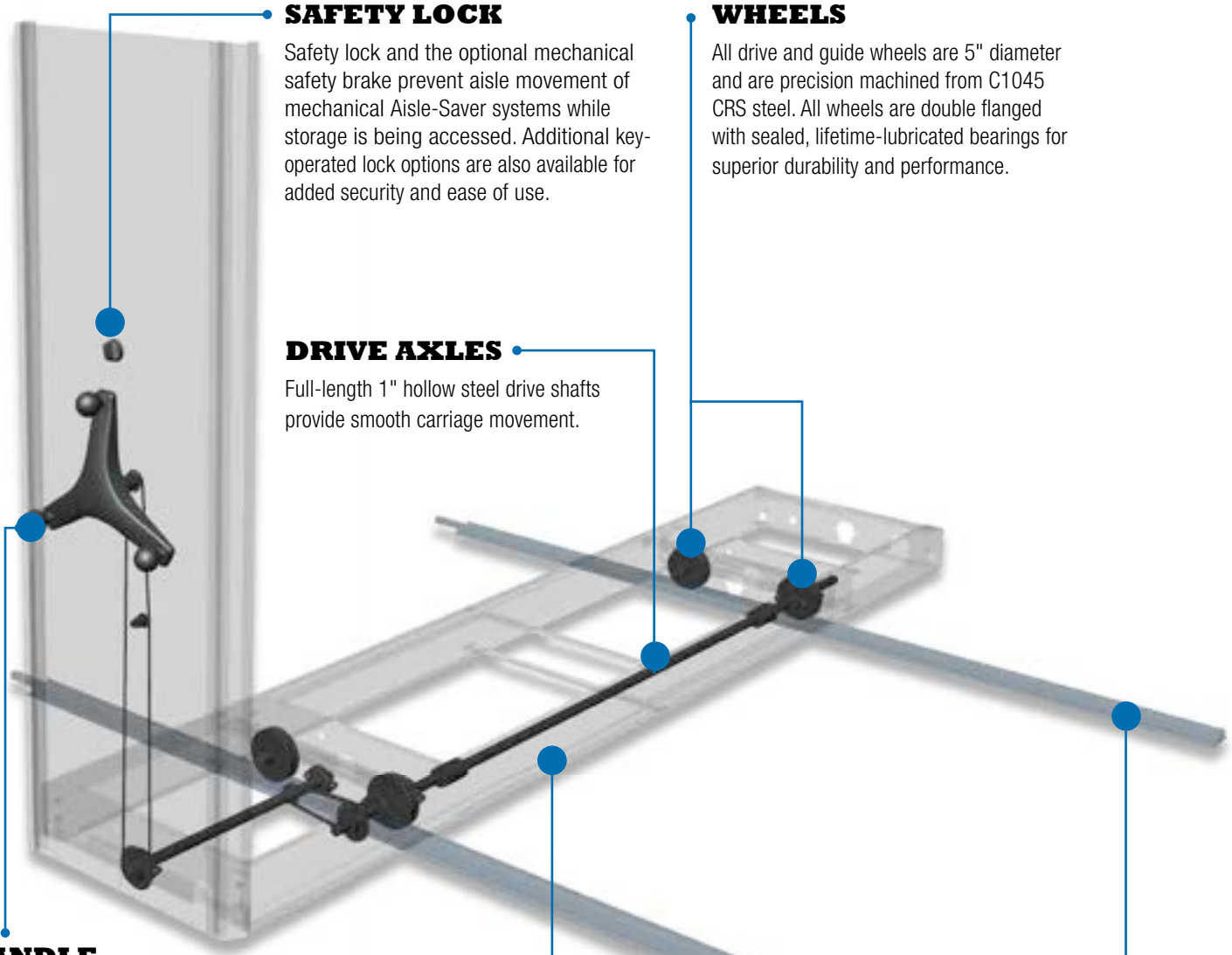

SAFETY LOCK

Safety lock and the optional mechanical safety brake prevent aisle movement of mechanical Aisle-Saver systems while storage is being accessed. Additional key-operated lock options are also available for added security and ease of use.

WHEELS

All drive and guide wheels are 5" diameter and are precision machined from C1045 CRS steel. All wheels are double flanged with sealed, lifetime-lubricated bearings for superior durability and performance.

DRIVE AXLES

Full-length 1" hollow steel drive shafts provide smooth carriage movement.

HANDLE

Ergonomic handle design and powerful 6:1 drive ratios are capable of moving 6,000 lbs. with just 1lb. of pressure.

CARRIAGE

Heavy-duty carriages are constructed of 12 ga. cold rolled steel with welded side channels, torsion channels, and cross-members for added strength and durability. Carriages are rated for maximum loads of 1,000 lbs. per linear foot.

TRACK

Heavy-duty 13-gauge C1045 CRS steel construction matches wheel hardness to reduce wear and provide longer service life and optimal performance. Optional seismic track systems feature 8-gauge steel seismic gripper plates.

OPTIMUM STORAGE



37'

Typical Storage Configuration



20'

Optimum storage configuration with
Aisle-Saver® High Density Storage System

AISLE-SAVER®



Borroughs Mechanical Aisle-Saver® is used by this military installation to provide parachute packing surfaces that can be moved & compacted when not in use.

MODULAR OPTIONS – FLEXIBLE SOLUTIONS



HIGH DENSITY DRAWER SYSTEMS



Virtually unlimited partitioning and divider combinations allow you to design a system to improve space-efficiency as well as organizational productivity. Drawers protect storage from the environment while significantly improving retrieval time.

BOX EDGE PLUS INDUSTRIAL SHELVING



Ideal for general storage of large, heavy or bulky parts. Box Edge Plus steel shelf construction features a closed, welded box shape design with welded corners for added rigidity, strength and impact resistance.

Borroughs Aisle-Saver Systems can be designed using any Borroughs product line. Some of the more common industrial implementations of Borroughs mobile storage technology incorporate Box Edge Plus, HD Drawers, Rivet-Span, B-Span, or a combination of two or more of these product lines.

RIVET-SPAN BOLTLESS SHELVING



Economical, strong, and simple to assemble, Rivet-Span offers a variety of beam choices to accommodate a wide range of loads, with spans and depths wider and deeper than conventional shelving choices.

B-SPAN WIDE-SPAN SHELVING



B-Span is ideal for non-palletized, heavy loads, and perfect when you need wide-span, higher capacity shelving. B-Span can accommodate a variety of configuration options, and is perfect for non-palletized, heavy loads.

SLOTTED ANGLE **Customize, Cut, Construct.**

Use Borroughs Slotted Angle to create an almost endless variety of system solutions and solve even the most unusual challenge for your project. Slotted Angle's universal, versatile bolt patterns (round and elongated) have been thoughtfully engineered to accommodate assembly without the need to drill holes. Slotted Angle is easily cut to size while in the field, and can be adapted to uses limited only by your imagination. Borroughs Slotted Angle is the ideal answer for non-standard size or special item racks, carts, worktables, and support framing construction. Solve your special storage challenges easily, quickly and more economically with Borroughs Slotted Angle.



Slotted Angle is used to connect grated decking to tops of Box Edge Units.

BEAMS

LIGHT DUTY

Light duty posts punched on 1^{1/2}" centers.



14
GAUGE
STEEL

PART #	LENGTH	W x D
SA125-10	10'	1.25" x 1.25"
SA160-10	10'	1.57" x 1.57"

MEDIUM DUTY

Medium duty posts punched on 1^{1/2}" centers.



14
GAUGE
STEEL

PART #	TYPE	W x D
SA225-10	10'	2.38" x 1.62"
SA225-12	12'	2.38" x 1.62"

HEAVY DUTY

Heavy duty posts punched on 1^{1/2}" centers.



12
GAUGE
STEEL

PART #	TYPE	W x D
SA312-10	10'	3.12" x 1.61"
SA312-12	12'	3.12" x 1.61"

BEAM SECTIONS (COMBINATIONS)

Beam Type	Load Capacities by Length							
	3'	4'	5'	6'	7'	8'	9'	10'
Light Duty 125	510 lbs.	290 lbs.	—	—	—	—	—	—
Light Duty 160	820 lbs.	540 lbs.	370 lbs.	260 lbs.	—	—	—	—
Med. Duty 225	1590 lbs.	1120 lbs.	830 lbs.	640 lbs.	510 lbs.	410 lbs.	—	—
H-Duty 312	2790 lbs.	1950 lbs.	1350 lbs.	1050 lbs.	840 lbs.	660 lbs.	480 lbs.	—
Light Duty 125	1080 lbs.	830 lbs.	585 lbs.	420 lbs.	—	—	—	—
Light Duty 160	1390 lbs.	1080 lbs.	855 lbs.	690 lbs.	560 lbs.	430 lbs.	—	—
Med. Duty 225	3090 lbs.	2230 lbs.	1690 lbs.	1380 lbs.	1130 lbs.	910 lbs.	730 lbs.	580 lbs.
H-Duty 312	6100 lbs.	4470 lbs.	3400 lbs.	2730 lbs.	2200 lbs.	1750 lbs.	1300 lbs.	1090 lbs.
Light Duty 125	1300 lbs.	960 lbs.	650 lbs.	440 lbs.	270 lbs.	—	—	—
Light Duty 160	1680 lbs.	1260 lbs.	960 lbs.	730 lbs.	580 lbs.	480 lbs.	—	—
Med. Duty 225	3740 lbs.	2930 lbs.	2300 lbs.	1810 lbs.	1460 lbs.	1170 lbs.	960 lbs.	800 lbs.
H-Duty 312	7860 lbs.	5940 lbs.	4690 lbs.	3885 lbs.	4330 lbs.	2740 lbs.	2210 lbs.	1870 lbs.
Light Duty 125	750 lbs.	660 lbs.	530 lbs.	400 lbs.	—	—	—	—
Light Duty 160	970 lbs.	870 lbs.	780 lbs.	660 lbs.	570 lbs.	450 lbs.	—	—
Med. Duty 225	2170 lbs.	1800 lbs.	1540 lbs.	1330 lbs.	1160 lbs.	970 lbs.	860 lbs.	690 lbs.
H-Duty 312	4190 lbs.	3580 lbs.	3190 lbs.	2810 lbs.	2490 lbs.	2190 lbs.	1990 lbs.	1830 lbs.
Light Duty 125	—	—	—	—	—	—	—	—
Light Duty 160	—	—	—	—	—	—	—	—
Med. Duty 225	6370 lbs.	4680 lbs.	3570 lbs.	3010 lbs.	2630 lbs.	2340 lbs.	2110 lbs.	1910 lbs.
H-Duty 312	12750 lbs.	9650 lbs.	7610 lbs.	6610 lbs.	5800 lbs.	5100 lbs.	4590 lbs.	4070 lbs.

ADDITIONAL HARDWARE

Package of (75) bolts with serrated shoulder nuts and (30) washers.



PART #
00527-000

• Combination sections are bolted together on 6" centers. All figures refer to a pair of beams carrying evenly distributed loads. For concentrated loads, these figures are halved. The loads shown above are those which give a safety factor of 1.5 while limiting deflection.

SLOTTED ANGLE CONFIGURATIONS

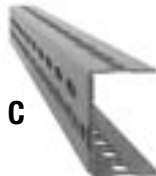

HIGH-RISE & MULTI-TIER

HIGH-RISE & MULTI-TIER Go Vertical and Optimize Unused Space.

Borrighs adaptable Multi-Level Storage Systems give you the ability to take your facility to the next level of cost performance and storage capacity. Borrighs versatile High-Rise or Multi-Level Storage Systems will maximize your facility's usable space by optimizing unused vertical space. Borrighs High-Rise and Multi-Level Storage Systems bring efficiency, functionality and performance to this otherwise vacant space.



(01)



(02)



(03)



(04)



(05)



(06)



(07)

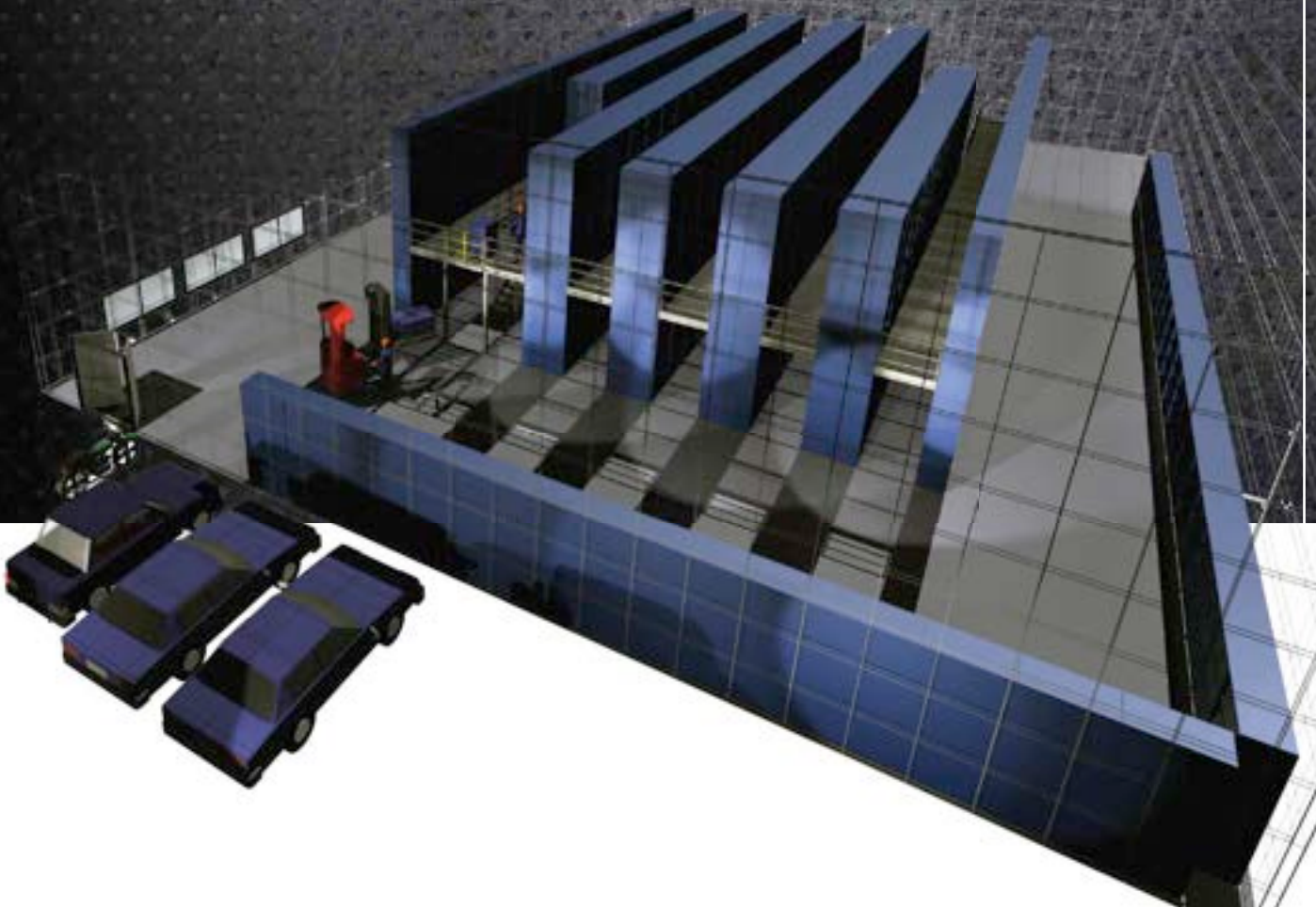

CONNECTED AND ADAPTABLE

Borroughs is the expert in High-Rise and Multi-Level Storage Systems, and has engineered a wide variety of storage system options that allow you to create exactly the kind of storage that works for your facilities' complex needs. High-Rise and Multi-Level Systems add additional levels to existing shelving systems without having to disassemble existing shelving. Borroughs Multi-Level Storage Systems can adapt to practically any free-standing or fixed storage structures in your facility. Borroughs can provide the shelving options and components to enhance the performance and capability of existing Multi-Level Systems economically and efficiently.



MULTI-LEVEL CATWALK SYSTEMS

Multi-Level Catwalk Systems are economical, easily extend storage to a second level and expand the storage capacity of your lower level system. They provide load capacities to meet average industrial demands for medium and lightweight items in a wide range of sizes and shapes. Multi-Level Catwalk Systems are designed to integrate perfectly with barcoding, robotic, and wire guided picking systems, and are perfect for storage of small to medium sized, non-palletized material. When your facility demands increased storage space, Multi-Level Catwalk Systems are a logical, cost effective choice.

- Strong Construction
- Superior Design
- Comprehensive Installation



MULTI-LEVEL FULL-MAT SYSTEMS

Utilize a solid or grated floor on top of a shelving supported system. Multi-Level Full-Mat Systems are a favorite with automotive dealerships, distributors and warehouses that need to accommodate large items with cumbersome and hard to store shapes and sizes.

- Strong Construction
- Easily Adjustable & Flexible
- Quality Decking Options
- Top Quality Stairs & Railings



HIGH-RISE SHELVING SYSTEMS

Borroughs High-Rise Shelving systems maximize your facility's usable space by optimizing unused vertical space. Shelving systems typically reach 20'-30' high. High-Rise systems can be designed using Borroughs' Box Edge Plus, B-Span or Rivet-Span shelving. Higher storage levels can be accessed with anything from a rolling ladder to a "man aboard" order picker. High-Rise systems are utilized in high density warehousing and distribution centers, and are ideal for archive facilities or slower moving inventory environments.

- Strong Construction
- Superior Design
- Comprehensive Installation

PROVEN METHODS OF INCREASING EXISTING STORAGE AREA

Borroughs shelving supported Multi-Level Storage Systems are an excellent solution for many hand-loaded shelving needs and are designed to provide load capacities to meet average industrial demands for medium and lightweight items in a wide range of sizes and shapes. Borroughs Multi-Level Systems are the number one choice of major retail distributors, medical data or archival facilities, and automotive distribution centers throughout North America. By using angle, beaded or high-rise posts, Borroughs Box Edge Plus shelving can be configured to meet your capacity requirements. Depending on requirements, Rivet-Span and Flexi-bins can also be used in conjunction with Box Edge Plus to create shelving supported Multi-Level Storage Systems. When your facility demands increased storage space, Multi-Level Storage Systems are a logical, cost effective choice.



FREE-STANDING MEZZANINES (WORK PLATFORM)

Free-standing second or third-levels use large columns for support rather than shelving. Under most tax laws, Free-standing Mezzanines are considered equipment rather than structures, minimizing additional property taxes and allowing for equipment depreciation advantages. Each Borroughs Free-standing Mezzanine is custom designed to offer the best possible utilization of space. All systems are PE stamped to ensure system design integrity and structural safety.

- Strong Construction
- Superior Design
- Comprehensive Installation
- Top Quality Stairs & Railings

MULTI-LEVEL CAP SYSTEMS (NOT SHOWN)

A hybrid of Multi-Level Catwalk and Full-Mat Systems, provides the advantage of minimizing installation times and labor costs through the use of caps, which fit over post tops and eliminate the need for splices. In addition, the cap also functions as a face aisle beam, eliminating beams and brackets. Not recommended for use in Seismic Zones 3 and 4.

INDEX

Box Edge Plus7
 Design Features8-9
 Basic Data 10
 Building Your Shelving System... 11
 Open-Type Units 12
 Closed-Type Units (without backs) . 12
 Closed-Type Units (with backs)..... 13
 Bin-Type Units..... 14
 Counter-Type Units..... 15
 Beaded Posts..... 16
 Angle Posts 16
 High-Rise Posts..... 16
 Beaded Posts-Closed Sides 17
 Angle Posts-Closed Sides..... 17
 High Rise Posts Closed Sides.... 18
 Foot Plate - Front 18
 Shim Plate - Front 18
 Foot Plate Back to Back 18
 Shim Plate Back to Back..... 18
 High Rise Foot Plate..... 18
 Cross Braces 19
 Angle Post Face Braces 19
 Beaded Post Face Brace 19
 Shelving Backs..... 19
 Shelves..... 20
 Shelf Lock..... 20
 Shelf Clip 20
 Hardware 20
 Fixed Shelf Dividers..... 21
 Sliding Shelf Dividers 21
 Angle Shelf Dividers 21
 Shelf Side Supports 21
 Shelf Saddle Reinforcements..... 21
 Shelf Boxes 22
 Partitions for Shelf Box (dividers).. 22
 Box Guides..... 22
 Angle Post Bin Fronts..... 22
 Angle Post Bin Front Clips 22

Beaded Post Bin Fronts 22
 Base Strips 23
 Boltless Hang Bars..... 23
 Label Holders 23
 Long Parts Frames 23
 Corner Splicers..... 24
 Splice Bars 24
 Splicer Plate 24
 Beaded Post Splicer Kit 24
 High Rise Post Splicer Kit 24
 Catwalk Beams 24
 Framed Swing Doors..... 28
 Cabinet-Type Units..... 28
 Counter Backs..... 29
 Counter Tops 29
 Ledge Tops..... 29
High Density (HD) Drawers.....31
 Sizes and Specifications 32
 Features..... 32
 Partitions 33
 Dividers..... 33
 Configuring Drawer Systems..... 34
 Pre-configured Drawer Units .. 36-37
 Pre-configured Interiors..... 38-43
 Roll-Out Shelves..... 43
 Drawer Mounting Uprights 43
 Drawer Partitions..... 44
 Drawer Dividers 44
Rivet-Span 45
 Beam Examples 46
 Beam Profiles 46
 Beam Capacities 47
 Post Capacities 47
 Single Rivet Shelf Units 49
 Double Rivet Shelf Units 49
 Bulk Storage Units 50-52
 Pre-configured Z-Beam Units 54
 Automotive Storage Units 54
 Tire Racks 55
 Angle Post 56
 T Post 56
 HD Angle Post..... 56
 Single Rivet Beam 56
 Double Rivet Channel Beam 56
 Double Rivet Low Profile Beam.. 56
 Tire Beam 56
 Double Rivet Angle Beam 57
 Double Rivet Z Beam 57
 Z Tie 57
 T Post Splicer 57
 Angle Post Splicer 57
 Angle Post Tie Plate 57
 Foot Plate 57
 Record Storage Support Angle .. 58
 Hang Rod 58
 Slotted Angle Cleat 58
 Aisle Tie 58
 Back Spacer Tie 58
 Wall Tie 58
 Support Tie..... 58
 Aisle/Full Mat Decking Support.. 59
 Particle Board Decking..... 59
 Wire Decking 59
 Specification Data 76
Modular Drawer Cabinets 61
 Cabinet Widths & Heights 62
 Drawer/Shelf Cabinet Options... 63
 Drawer Part # Definition 64
 Shelf Part # Definition..... 65
 23S Wide/Stand Up Height 66
 23S Wide/Bench Height 67
 23S Wide/Table Height..... 68
 23S Wide/Desk Height 68
 23S Wide/Drawer Interiors 69
 30S Wide/Eye Level Height..... 70
 30S Wide/Eye Level Height... 70-71
 30S Wide/Counter Height 72
 30S Wide/Stand Up Height 73
 30S Wide/Bench Height 74
 30S Wide/Table Height..... 75
 30S Wide/Desk Height 75
 30S Wide/Drawer Interiors 76

45S Wide/Eye Level Height... 77-78	Wall Mount Bench 102	B-Span Capacities 122
45S Wide/Counter Height 79	WCL Benches..... 104	Accessories 123
45S Wide/Stand Up Height 80	Locking Sliding Door Kit..... 104	Bracing Patterns..... 124
45S Wide/Bench Height..... 80	Transmission Tear-Down Bench..... 104	Aisle-Saver.....125
45S Wide/Drawer Interiors 81	Tire Racks..... 105	Mechanical Assist Systems..... 126
60S Wide/Eye Level Height 82	Battery Racks 105	Optimizing Space 127
60S Wide/Counter Height 83	Bumper Racks..... 105	Slotted Angle129
60S Wide/Stand Up Height 84	Automotive Workstation Info.. 106-107	Light Duty Beams 130
60S Wide/Bench Height 84	Modu-Benches..... 108	Medium Duty Beams..... 130
60S Wide/Drawer Interiors 85	Grooved Key Lock..... 108	Heavy Duty Beams..... 130
Hardwood Tops 86	Padlock Hasp 108	Beam Sections (Combinations) ... 130
Stainless Steel Tops 86	Modu-Drawer Unit..... 109	Additional Hardware..... 130
Flush Swing Doors 86	Tier Drawer Base..... 109	Slotted Angle Configurations 130
Caster Kits..... 87	Modu-Bench Cabinet 109	High-Rise & Multi-Tier Systems.....131
External Lock Bars 87	Tier Drawers 109	Multi-Level Catwalk Systems ... 132
Removable Lock Cores/Keys 87	Tier Drawer Pedestal Supports 109	Multi-Level Full-Mat Systems.... 132
Ribbed Rubber Retainer Tops 87	Hanging Drawer Pedestal..... 109	High-Rise Shelving Systems 132
Drawer Dividers (front to back)... 88	RTA Storage Cabinets 110	Free-Standing Mezzanines..... 133
Drawer Dividers (side to side).... 88	Counter Height Cabinet..... 110	Multi-Level Cap Systems 133
Roll-Out Shelves..... 88	Caster Base 110	
Drawer Dividers 89	Extra Shelves..... 110	
Static Shelves..... 89	Coat Rod Kit..... 110	
Mini-Mezzanine Systems 90	Garment Cabinet 111	
Flexi-Bins 91	XL Cabinet..... 111	
Flexi-Bin (Preconfigured units) ... 92	Combo Storage Cabinet 111	
Components & Accessories 93	45" Combination Cabinets 112	
Bin Frames 93	60" Combination Cabinets 113	
Shop Equipment.....95	Mobile Combination Cabinets.. 114	
Work Benches 96-97	Mobile Side-by-Side Cabinets . 115	
Semi-Portable Kit 97	Service Carts 116	
Portable Kit..... 97	Industrial Utility Cart..... 116	
Leveling Screws 97	Extra Shelves..... 116	
Bench Components & Access. ... 98	Counter Unit With Stainless Steel	
Bench Tops..... 100-101	B-Span117	
Wall Mount Bench 102	Posts 118	
Wall Mount Leg 102	Beams 118	
Wall Mount Cabinet..... 102	Clips 118	
Wall Mount Cabinet Angle Top Kit 102	Frames 118	
Upper Cabinets 102	Deck Over & Flush Bottom Beams . 118	
WTL Benches 103	Posts 118	
Caster Base 102	Decking 122	